

jaga

CLIMATE DESIGNERS

Verwarmen 

LINEA PLUS TECHNISCHE INFORMATIE



LINEA PLUS ■ OVERZICHT WARMTEWISSELAARS

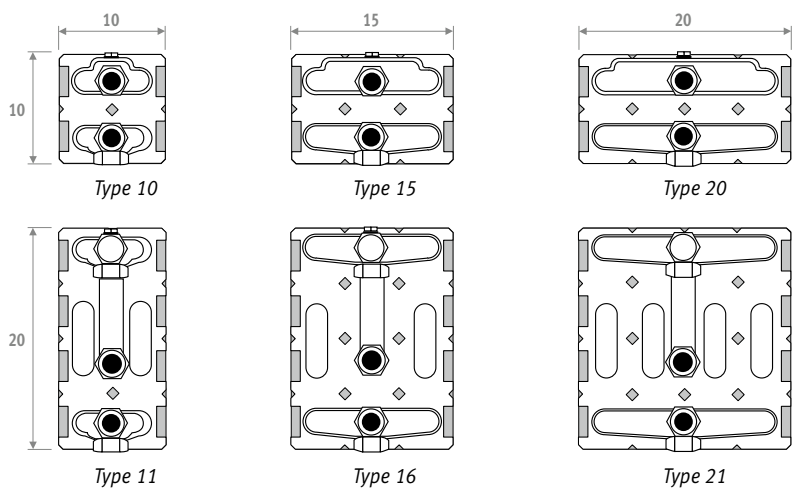

Gewicht en waterinhoud zonder verpakking of opties.

WANDMODEL GEWICHT IN KG

Type	H 20	35	50	65	95
10	5.9	8.2	10.6	13.0	15.4
11	---	9.7	12.1	14.4	19.1
15	7.0	9.5	12.1	14.7	17.0
16	---	12.0	14.6	17.2	22.4
20	8.2	11.0	13.8	16.7	18.8
21	---	14.3	17.1	19.9	25.6

WATERINHOUD IN LITER/METER

Type	Alle hoogtes
10	0.65
11	1.33
15	0.98
16	1.98
20	1.32
21	2.66

VRIJSTAAND MODEL GEWICHT IN KG

Type	H 20	35
10	10.2	14.3
11	---	15.8
15	11.5	15.9
16	---	18.6

CORRECTIEFACTOREN STATISCH

De opgegeven vermogens bij ΔT 50 en ΔT 30 zijn exacte waarden. ΔT 50 gemeten volgens EN 442. ΔT 30 berekend volgens EN 442. Voor alle andere ΔT geeft deze tabel een gemiddelde correctiefactor geldig voor alle afmetingen.

Op www.jaga.com/downloads/selectiontools kunt u berekeningstools downloaden met de exacte afgiftes. De online berekeningstools worden steeds up to date gehouden met de meest recente gegevens. Minieme afgifteverschillen tussen reeds gedrukte tabellen en de verschillende online berekeningstools zijn daarom volstrekt normaal en vallen binnen de door de norm vastgelegde tolerantie marges.

GEMIDDELDE CORRECTIEFACTOREN STATISCHE PRODUCTEN VOLGENS EN442 - 75/65/20°C

Kamertemp.: 20°C										Kamertemp.: 24°C											
Gemiddelde N-waarde: 1.36										Gemiddelde N-waarde: 1.36											
Ta	Tr	65	60	55	50	45	40	35	30	25	Ta	Tr	65	60	55	50	45	40	35	30	25
75		1.00	0.93	0.85	0.77	0.69	0.61	0.52	0.42	0.31	75		0.89	0.82	0.75	0.67	0.59	0.51	0.41	0.31	0.16
70		0.94	0.87	0.79	0.72	0.64	0.56	0.48	0.39	0.28	70		0.83	0.76	0.69	0.62	0.54	0.47	0.38	0.28	0.14
65			0.80	0.74	0.67	0.60	0.52	0.44	0.35	0.25	65			0.70	0.64	0.57	0.50	0.43	0.35	0.25	0.12
60				0.68	0.61	0.55	0.48	0.40	0.32	0.23	60				0.58	0.52	0.45	0.38	0.31	0.23	0.11
55					0.56	0.50	0.43	0.36	0.29	0.20	55					0.47	0.41	0.34	0.28	0.20	0.09
50						0.44	0.38	0.32	0.25	0.18	50						0.36	0.30	0.24	0.17	0.08
45							0.34	0.28	0.22	0.15	45							0.26	0.20	0.14	0.06
40								0.24	0.19	0.13	40								0.17	0.12	0.05
35									0.15	0.10	35									0.09	0.03
30										0.07	30										0.02

GEADVISEERD MAXIMAAL WATERDEBIET PER BUISDIAMETER BIJ MAX. WATERSNELHEID 0.4 M/S

Buis	Buiten Ø	Wanddikte	Maximaal debiet	Maximaal vermogen bij ΔT (°C) (T aanvoer - T retour)				
				ΔT 2	ΔT 5	ΔT 10	ΔT 20	ΔT 30
				Watt	Watt	Watt	Watt	Watt
	mm	mm	kg/u					
10/1	10.0	1.0	72	168	421	841	1682	2524
12/1	12.0	1.0	113	263	657	1314	2629	3943
12/2	12.0	2.0	72	168	421	841	1682	2524
14/1	14.0	1.0	163	379	946	1893	3785	5678
14/2	14.0	2.0	113	263	657	1314	2629	3943
15/1	15.0	1.0	191	444	1111	2221	4443	6664
16/1	16.0	1.0	222	515	1288	2576	5152	7729
16/1.5	16.0	1.5	191	444	1111	2221	4443	6664
16/2	16.0	2.0	163	379	946	1893	3785	5678
16/2.2	16.0	2.2	152	354	884	1769	3537	5306
17/2	17.0	2.0	191	444	1111	2221	4443	6664
3/8"	17.1	3.2	129	301	752	1505	3010	4515
18/1	18.0	1.0	289	673	1682	3365	6730	10095
18/2	18.0	2.0	222	515	1288	2576	5152	7729
20/2	20.0	2.0	289	673	1682	3365	6730	10095
1/2"	21.3	3.7	217	504	1259	2518	5035	7553
26/3	26.0	3.0	452	1052	2629	5258	10515	15773

LINEA PLUS - DRUKVERLIEZEN

DRUKVERLIES TYPE 10

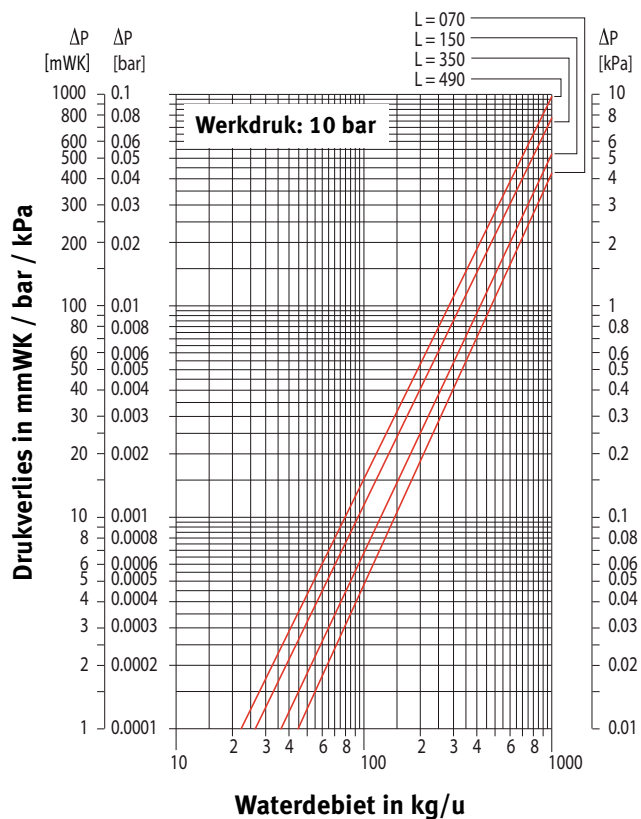

DRUKVERLIES TYPE 11

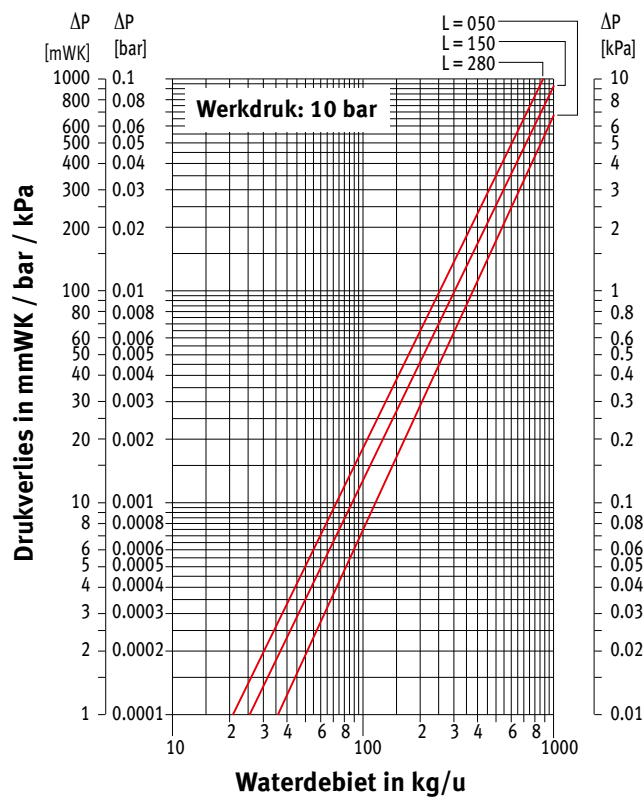

DRUKVERLIES TYPE 15

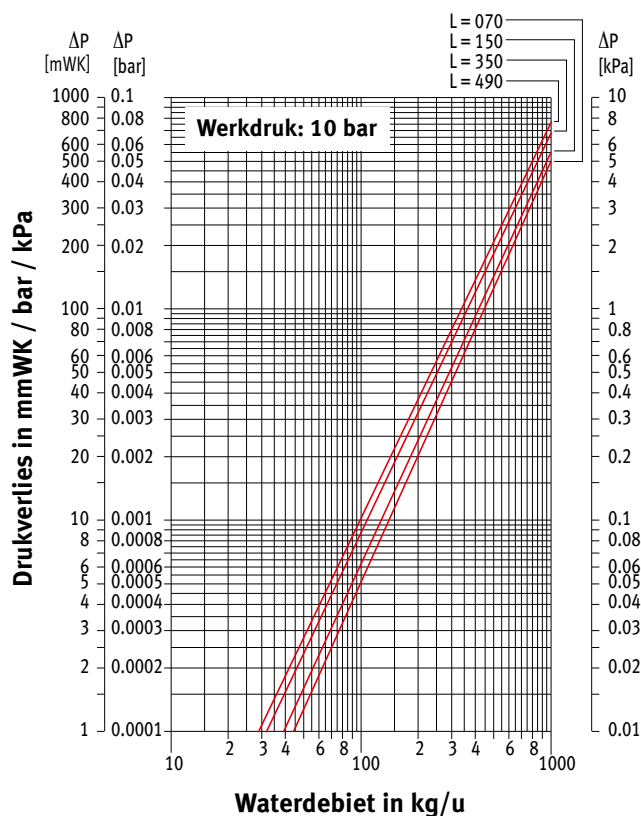

DRUKVERLIES TYPE 16

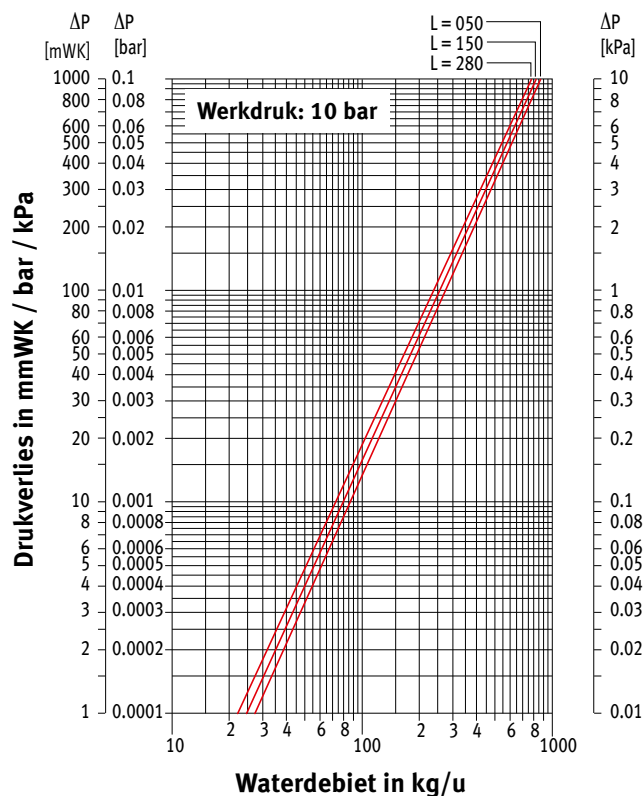

LINEA PLUS ■ DRUKVERLIEZEN

DRUKVERLIES TYPE 20

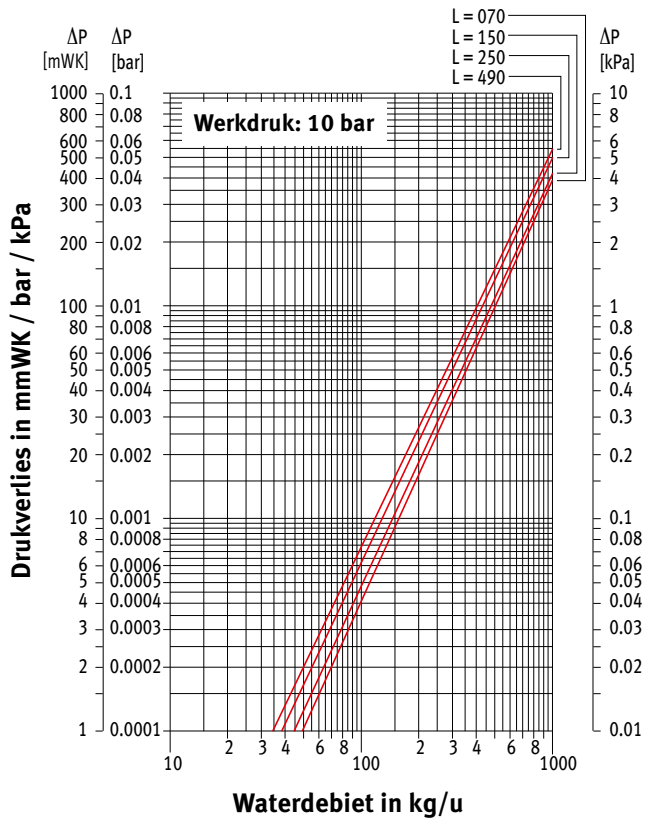

DRUKVERLIES TYPE 21

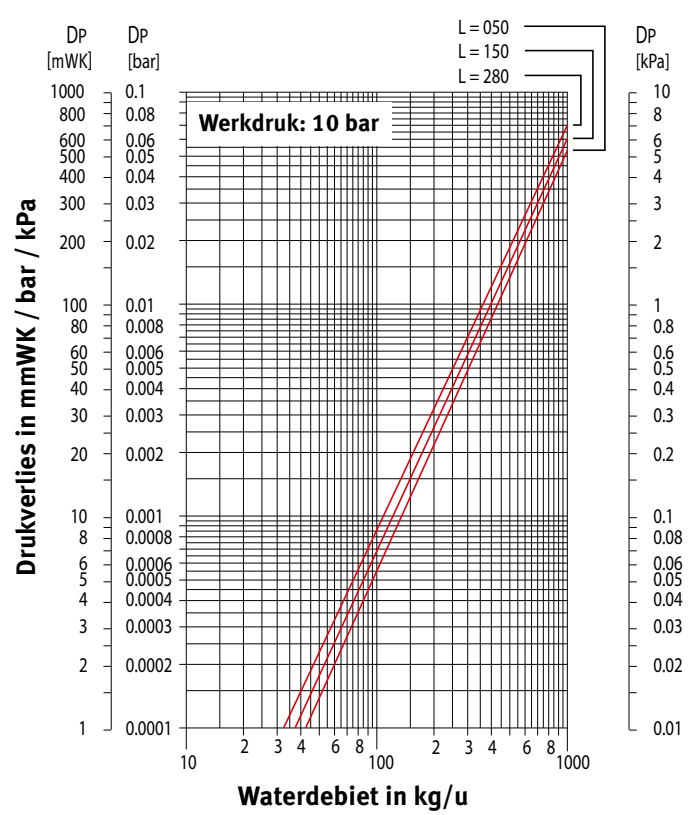

jaga

CLIMATE DESIGNERS

Jaga N.V.
Verbindingslaan 16
B-3590 Diepenbeek

Tel.: +32 (0)11 29 41 11
Fax: +32 (0)11 32 35 78
E-mail: info@jaga.com

Aangezien productontwikkeling een continu proces is, zijn alle vermelde gegevens onder voorbehoud van wijzigingen. Prijzen excl. BTW. Prijzen geldig vanaf 1 februari 2021. Vervangt alle bestaande prijslijsten.