

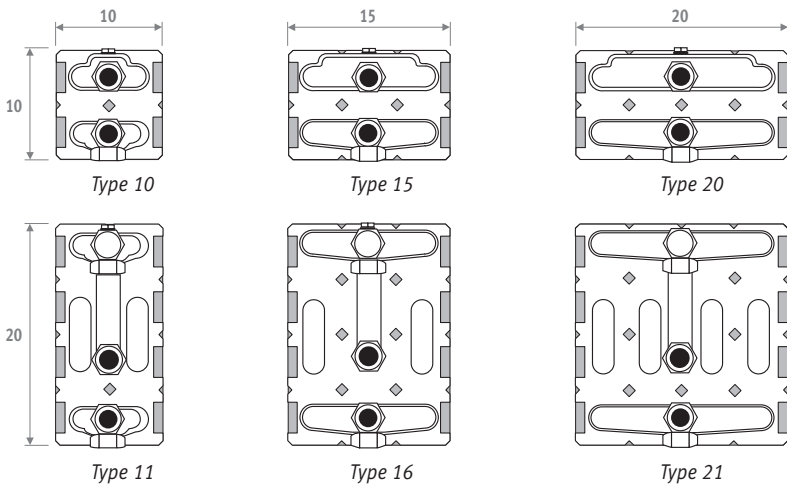

jaga

LINEA PLUS
Technical information

LINEA PLUS - OVERVIEW HEAT EXCHANGERS



Weight and water content without packaging or options.

WALL MOUNTED MODEL WEIGHT IN KG

Type	H	20	35	50	65	95
10		5.9	8.2	10.6	13.0	15.4
11	---		9.7	12.1	14.4	19.1
15		7.0	9.5	12.1	14.7	17.0
16	---		12.0	14.6	17.2	22.4
20		8.2	11.0	13.8	16.7	18.8
21	---		14.3	17.1	19.9	25.6

WATER CONTENT (IN LITRES/METRE)

Type	All heights
10	0.65
11	1.33
15	0.98
16	1.98
20	1.32
21	2.66

FREESTANDING MODEL WEIGHT IN KG

Type	H	20	35
10		10.2	14.3
11	---		15.8
15		11.5	15.9
16	---		18.6

CORRECTION FACTORS - LINEA PLUS

AVERAGE CORRECTION FACTORS ACCORDING TO EN442 - 75/65/20°C

Tv	Tl	Tr	25	30	35	40	45	50	55	60	65	70	75	80	85
90	18		0.45	0.58	0.69	0.79	0.89	0.98	1.07	1.16	1.24	1.34	1.41	1.49	1.56
	20		0.38	0.52	0.63	0.74	0.83	0.92	1.01	1.10	1.18	1.28	1.35	1.43	1.50
	22		0.30	0.46	0.57	0.68	0.78	0.87	0.96	1.04	1.13	1.22	1.30	1.37	1.44
	24		0.20	0.39	0.52	0.62	0.72	0.81	0.90	0.99	1.07	1.15	1.24	1.31	1.38
85	18		0.42	0.54	0.65	0.75	0.84	0.93	1.01	1.10	1.20	1.27	1.34	1.41	
	20		0.36	0.49	0.59	0.69	0.79	0.87	0.96	1.04	1.12	1.21	1.28	1.35	
	22		0.28	0.42	0.54	0.64	0.73	0.82	0.90	0.99	1.06	1.15	1.22	1.30	
	24		0.19	0.36	0.48	0.58	0.68	0.76	0.85	0.93	1.01	1.10	1.17	1.24	
80	18		0.39	0.51	0.61	0.70	0.79	0.88	0.96	1.04	1.12	1.20	1.27		
	20		0.33	0.45	0.56	0.65	0.74	0.82	0.90	0.98	1.07	1.14	1.21		
	22		0.26	0.39	0.50	0.60	0.68	0.77	0.85	0.93	1.01	1.08	1.15		
	24		0.17	0.34	0.45	0.54	0.63	0.72	0.80	0.87	0.96	1.03	1.10		
75	18		0.37	0.47	0.57	0.66	0.74	0.82	0.90	0.99	1.05	1.12			
	20		0.30	0.42	0.52	0.61	0.69	0.77	0.85	0.93	1.00	1.07			
	22		0.24	0.36	0.46	0.55	0.64	0.72	0.79	0.88	0.95	1.01			
	24		0.16	0.31	0.41	0.50	0.59	0.67	0.74	0.83	0.89	0.96			
70	18		0.34	0.44	0.53	0.61	0.69	0.77	0.85	0.92	0.99				
	20		0.28	0.39	0.48	0.56	0.64	0.72	0.80	0.87	0.93				
	22		0.22	0.33	0.43	0.51	0.59	0.67	0.74	0.81	0.88				
	24		0.14	0.28	0.38	0.46	0.54	0.62	0.69	0.76	0.83				
65	18		0.31	0.40	0.49	0.57	0.64	0.71	0.79	0.85					
	20		0.25	0.35	0.44	0.52	0.59	0.66	0.74	0.80					
	22		0.19	0.30	0.39	0.47	0.54	0.61	0.69	0.75					
	24		0.12	0.25	0.34	0.42	0.50	0.57	0.64	0.70					
60	18		0.28	0.37	0.45	0.52	0.59	0.66	0.73						
	20		0.23	0.32	0.40	0.47	0.54	0.62	0.68						
	22		0.17	0.27	0.35	0.43	0.50	0.57	0.63						
	24		0.11	0.23	0.31	0.38	0.45	0.52	0.58						
55	18		0.25	0.33	0.40	0.47	0.55	0.60							
	20		0.20	0.29	0.36	0.43	0.50	0.56							
	22		0.15	0.24	0.32	0.38	0.45	0.51							
	24		0.09	0.20	0.27	0.34	0.40	0.47							
50	18		0.22	0.30	0.36	0.43	0.49								
	20		0.18	0.25	0.32	0.38	0.44								
	22		0.13	0.21	0.28	0.34	0.40								
	24		0.08	0.17	0.24	0.30	0.36								
45	18		0.19	0.26	0.32	0.38									
	20		0.15	0.22	0.28	0.34									
	22		0.11	0.18	0.24	0.30									
	24		0.06	0.14	0.20	0.26									
40	18		0.16	0.22	0.28										
	20		0.12	0.18	0.24										
	22		0.09	0.15	0.20										
	24		0.05	0.12	0.17										
35	18		0.13	0.19											
	20		0.10	0.15											
	22		0.07	0.12											
	24		0.03	0.09											
30	18		0.10												
	20		0.07												
	22		0.04												
	24		0.02												

The indicated outputs with ΔT 50 and ΔT 60 are the exact outputs. ΔT 50 output measured in accordance with EN 442 and ΔT 60 output calculated according to EN 442. An average correction factor is given in this table for all other ΔT outputs, applicable for all dimensions.

LINEA PLUS - PRESSURE DROP

PRESSURE DROP TYPE 10

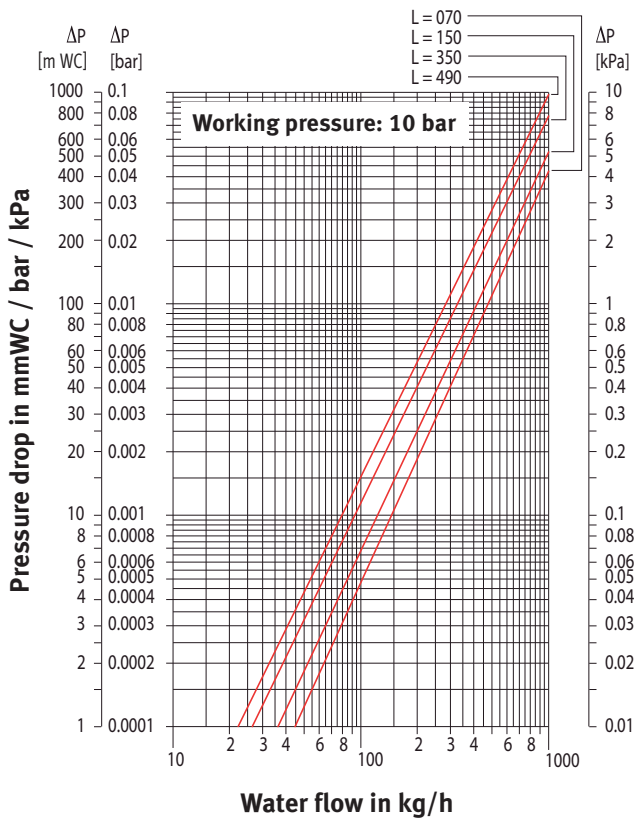

PRESSURE DROP TYPE 11

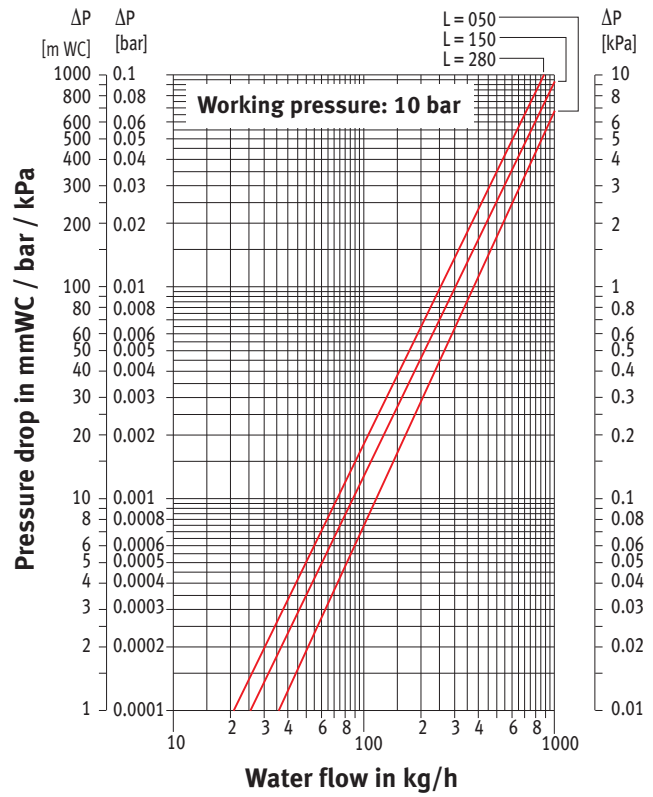

PRESSURE DROP TYPE 15

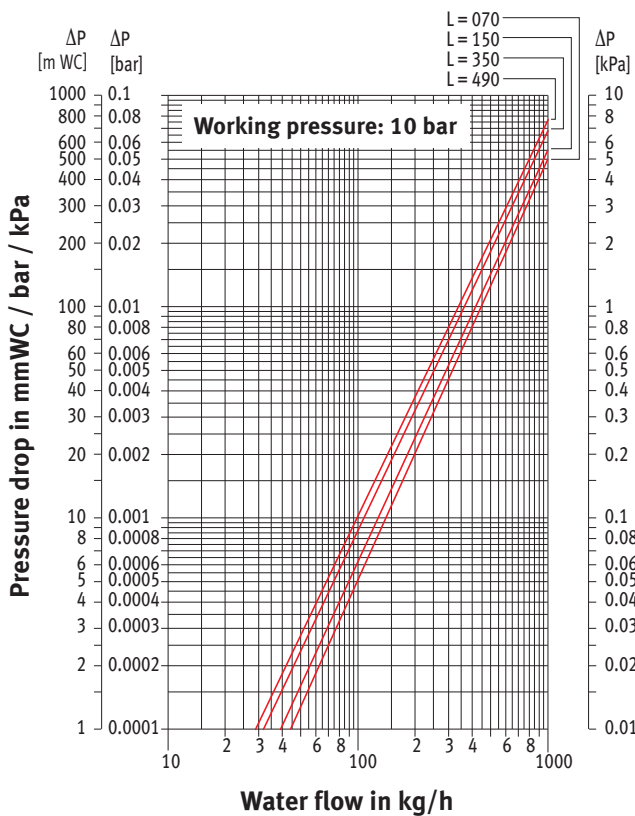

PRESSURE DROP TYPE 16

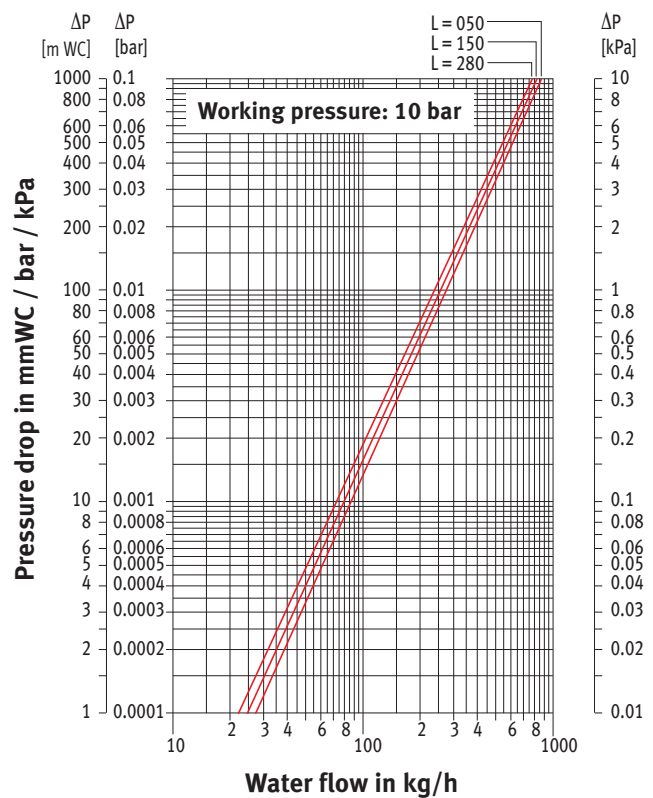

LINEA PLUS - PRESSURE DROP

PRESSURE DROP TYPE 20

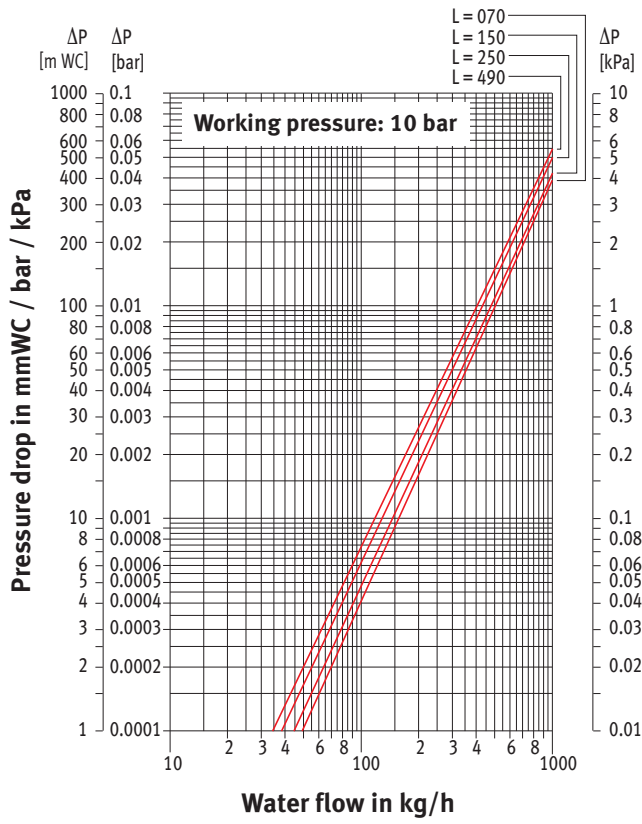

PRESSURE DROP TYPE 21

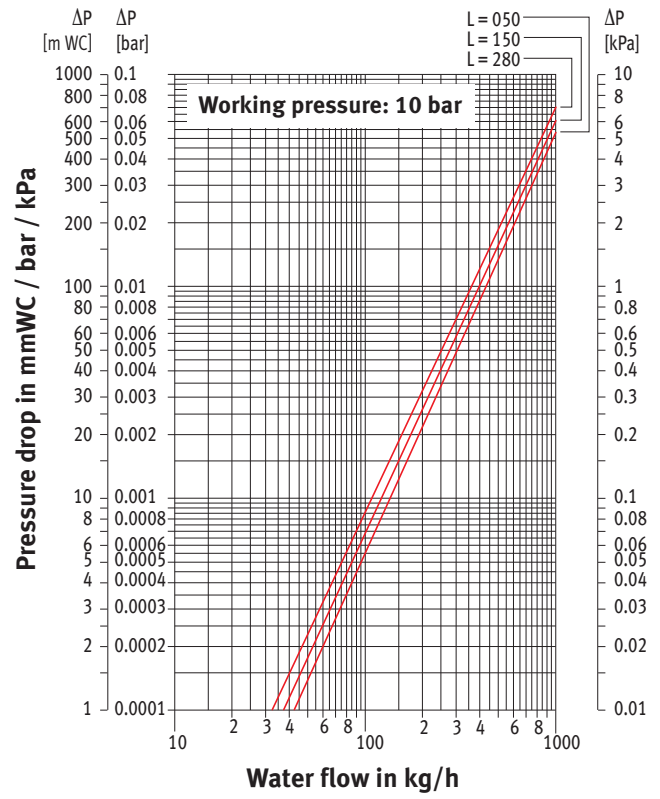

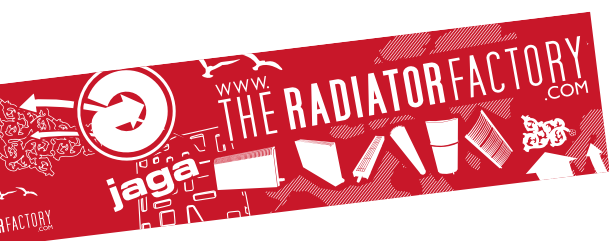

Jaga International
Verbindingslaan 16
B-3590 Diepenbeek

Tel.: +32 11 29 41 12
Fax: +32 11 29 41 60
E-mail: export@jaga.be
www.jaga.be

The information in this price list is correct at the time of printing.
Jaga reserves the right to change product specification at any time in
line with our policy of continuous improvement and innovation.