

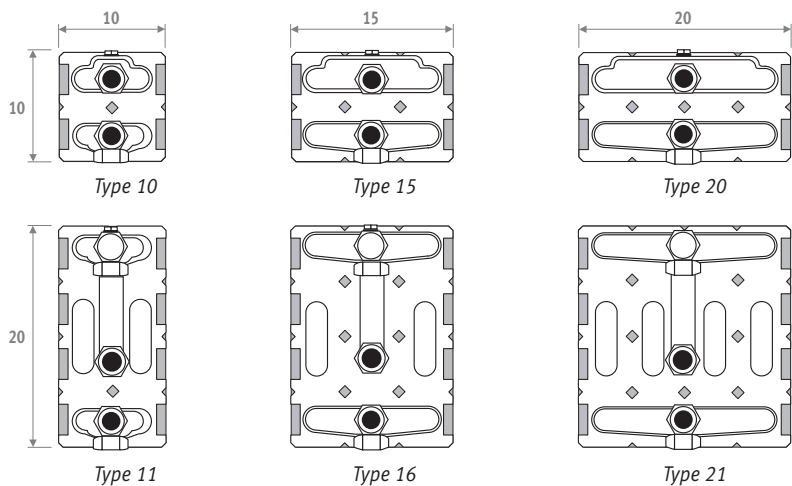

jaga

WANDINBOUW
Technische informatie

WANDINBOUW ■ OVERZICHT WARMTEWISSELAARS



Gewicht en waterinhoud zonder verpakking of opties.

WANDMODEL GEWICHT IN KG/METER

Type	H	20	30	40	50
10		3.9	4.9	5.9	6.9
11		---	6.5	7.5	8.5
15		5.1	6.1	7.2	8.2
16		---	8.7	9.7	10.8
20		6.2	7.3	8.5	9.6
21		---	10.3	11.4	12.6

WATERINHOUD IN LITER / METER

Type	Alle hoogtes
10	0.65
11	1.33
15	0.98
16	1.98
20	1.32
21	2.66

CORRECTIEFACTOREN - WANDINBOUW

GEMIDDELDE CORRECTIEFACTOREN VOLGENS EN442 - 75/65/20°C

Tv	Tl	Tr	25	30	35	40	45	50	55	60	65	70	75	80	85
90	18		0.45	0.58	0.69	0.79	0.89	0.98	1.07	1.16	1.24	1.34	1.41	1.49	1.56
	20		0.38	0.52	0.63	0.74	0.83	0.92	1.01	1.10	1.18	1.28	1.35	1.43	1.50
	22		0.30	0.46	0.57	0.68	0.78	0.87	0.96	1.04	1.13	1.22	1.30	1.37	1.44
	24		0.20	0.39	0.52	0.62	0.72	0.81	0.90	0.99	1.07	1.15	1.24	1.31	1.38
85	18		0.42	0.54	0.65	0.75	0.84	0.93	1.01	1.10	1.20	1.27	1.34	1.41	
	20		0.36	0.49	0.59	0.69	0.79	0.87	0.96	1.04	1.12	1.21	1.28	1.35	
	22		0.28	0.42	0.54	0.64	0.73	0.82	0.90	0.99	1.06	1.15	1.22	1.30	
80	24		0.19	0.36	0.48	0.58	0.68	0.76	0.85	0.93	1.01	1.10	1.17	1.24	
	18		0.39	0.51	0.61	0.70	0.79	0.88	0.96	1.04	1.12	1.20	1.27		
	20		0.33	0.45	0.56	0.65	0.74	0.82	0.90	0.98	1.07	1.14	1.21		
	22		0.26	0.39	0.50	0.60	0.68	0.77	0.85	0.93	1.01	1.08	1.15		
75	24		0.17	0.34	0.45	0.54	0.63	0.72	0.80	0.87	0.96	1.03	1.10		
	18		0.37	0.47	0.57	0.66	0.74	0.82	0.90	0.99	1.05	1.12			
	20		0.30	0.42	0.52	0.61	0.69	0.77	0.85	0.93	1.00	1.07			
	22		0.24	0.36	0.46	0.55	0.64	0.72	0.79	0.88	0.95	1.01			
70	24		0.16	0.31	0.41	0.50	0.59	0.67	0.74	0.83	0.89	0.96			
	18		0.34	0.44	0.53	0.61	0.69	0.77	0.85	0.92	0.99				
	20		0.28	0.39	0.48	0.56	0.64	0.72	0.80	0.87	0.93				
	22		0.22	0.33	0.43	0.51	0.59	0.67	0.74	0.81	0.88				
65	24		0.14	0.28	0.38	0.46	0.54	0.62	0.69	0.76	0.83				
	18		0.31	0.40	0.49	0.57	0.64	0.71	0.79	0.85					
	20		0.25	0.35	0.44	0.52	0.59	0.66	0.74	0.80					
	22		0.19	0.30	0.39	0.47	0.54	0.61	0.69	0.75					
60	24		0.12	0.25	0.34	0.42	0.50	0.57	0.64	0.70					
	18		0.28	0.37	0.45	0.52	0.59	0.66	0.73						
	20		0.23	0.32	0.40	0.47	0.54	0.62	0.68						
	22		0.17	0.27	0.35	0.43	0.50	0.57	0.63						
55	24		0.11	0.23	0.31	0.38	0.45	0.52	0.58						
	18		0.25	0.33	0.40	0.47	0.55	0.60							
	20		0.20	0.29	0.36	0.43	0.50	0.56							
	22		0.15	0.24	0.32	0.38	0.45	0.51							
50	24		0.09	0.20	0.27	0.34	0.40	0.47							
	18		0.22	0.30	0.36	0.43	0.49								
	20		0.18	0.25	0.32	0.38	0.44								
	22		0.13	0.21	0.28	0.34	0.40								
45	24		0.08	0.17	0.24	0.30	0.36								
	18		0.19	0.26	0.32	0.38									
	20		0.15	0.22	0.28	0.34									
	22		0.11	0.18	0.24	0.30									
40	24		0.06	0.14	0.20	0.26									
	18		0.16	0.22	0.28										
	20		0.12	0.18	0.24										
	22		0.09	0.15	0.20										
35	24		0.05	0.12	0.17										
	18		0.13	0.19											
	20		0.10	0.15											
	22		0.07	0.12											
30	24		0.03	0.09											
	18		0.10												
	20		0.07												
	22		0.04												
24		0.02													

De opgegeven vermogens bij ΔT 50 en ΔT 30 zijn exacte waardes. ΔT 50 gemeten volgens EN 442. ΔT 30 berekend volgens EN 442. Voor alle andere ΔT geeft deze tabel een gemiddelde correctiefactor geldig voor alle afmetingen.

WANDINBOUW MET DBE

CORRECTIEFACTOREN

GEMIDDELDE CORRECTIEFACTOREN
VOLGENS EN442 - 75/65/20°C

DBE
Dynamic Boost Effect

Tv	Tl	Tr	25	30	35	40	45	50	55	60	65	70	75	80	85
90	18		0.56	0.67	0.76	0.84	0.92	0.99	1.05	1.11	1.17	1.24	1.29	1.34	1.39
	20		0.49	0.62	0.71	0.80	0.87	0.94	1.01	1.07	1.13	1.20	1.25	1.30	1.35
	22		0.42	0.56	0.66	0.75	0.83	0.90	0.97	1.03	1.09	1.16	1.21	1.26	1.31
	24		0.31	0.50	0.61	0.71	0.79	0.86	0.93	0.99	1.05	1.11	1.17	1.22	1.27
85	18		0.53	0.64	0.73	0.81	0.88	0.95	1.01	1.07	1.14	1.19	1.24	1.29	
	20		0.47	0.59	0.68	0.76	0.84	0.91	0.97	1.03	1.09	1.15	1.20	1.25	
	22		0.39	0.53	0.63	0.72	0.79	0.86	0.93	0.99	1.05	1.11	1.16	1.21	
	24		0.29	0.47	0.58	0.67	0.75	0.82	0.89	0.95	1.01	1.07	1.12	1.17	
80	18		0.50	0.61	0.70	0.77	0.84	0.91	0.97	1.03	1.09	1.14	1.19		
	20		0.44	0.56	0.65	0.73	0.80	0.87	0.93	0.99	1.05	1.10	1.15		
	22		0.37	0.50	0.60	0.68	0.76	0.82	0.89	0.95	1.01	1.06	1.11		
	24		0.27	0.45	0.55	0.64	0.71	0.78	0.85	0.91	0.97	1.02	1.07		
75	18		0.48	0.58	0.66	0.74	0.80	0.87	0.93	0.99	1.04	1.09			
	20		0.42	0.53	0.62	0.69	0.76	0.82	0.88	0.95	1.00	1.05			
	22		0.35	0.48	0.57	0.65	0.72	0.78	0.84	0.91	0.96	1.01			
	24		0.25	0.42	0.52	0.60	0.68	0.74	0.80	0.87	0.92	0.97			
70	18		0.45	0.55	0.63	0.70	0.76	0.82	0.89	0.94	0.99				
	20		0.39	0.50	0.58	0.65	0.72	0.78	0.85	0.90	0.95				
	22		0.32	0.45	0.54	0.61	0.68	0.74	0.80	0.86	0.91				
	24		0.24	0.39	0.49	0.57	0.64	0.70	0.76	0.82	0.87				
65	18		0.42	0.51	0.59	0.66	0.72	0.78	0.84	0.89					
	20		0.36	0.47	0.55	0.62	0.68	0.74	0.80	0.85					
	22		0.30	0.42	0.50	0.57	0.64	0.70	0.76	0.81					
	24		0.22	0.36	0.46	0.53	0.60	0.66	0.72	0.77					
60	18		0.39	0.48	0.55	0.62	0.68	0.74	0.79						
	20		0.34	0.43	0.51	0.58	0.64	0.70	0.75						
	22		0.28	0.39	0.47	0.54	0.60	0.66	0.71						
	24		0.20	0.33	0.42	0.49	0.56	0.62	0.67						
55	18		0.36	0.44	0.51	0.58	0.64	0.69							
	20		0.31	0.40	0.47	0.54	0.60	0.65							
	22		0.25	0.35	0.43	0.49	0.55	0.61							
	24		0.17	0.30	0.39	0.45	0.51	0.57							
50	18		0.33	0.41	0.47	0.53	0.59								
	20		0.28	0.36	0.43	0.49	0.55								
	22		0.22	0.32	0.39	0.45	0.51								
	24		0.15	0.27	0.35	0.41	0.47								
45	18		0.30	0.37	0.43	0.49									
	20		0.25	0.33	0.39	0.45									
	22		0.20	0.28	0.35	0.41									
	24		0.13	0.24	0.31	0.37									
40	18		0.26	0.33	0.39										
	20		0.22	0.29	0.35										
	22		0.17	0.25	0.31										
	24		0.11	0.20	0.27										
35	18		0.23	0.29											
	20		0.18	0.25											
	22		0.14	0.21											
	24		0.08	0.16											
30	18		0.19												
	20		0.14												
	22		0.10												
	24		0.06												

De opgegeven vermogens bij $\Delta T 50$ en $\Delta T 30$ zijn exacte waarden. $\Delta T 50$ gemeten volgens EN 442. $\Delta T 30$ berekend volgens EN 442. Voor alle andere ΔT geeft deze tabel een gemiddelde correctiefactor geldig voor alle afmetingen.

WANDINBOUW MET DBE CORRECTIEFACTOREN GELUID



Gebruik van DBE:
max. aanvoertemperatuur 75°C
max. luchtvochtigheid 95% R.V.

Aantal units	GELUIDSNIVEAU COMFORT dB(A)						MAX. OPGENOMEN VERMOGEN (Watt)					
	1	2	3	4	5	6	1	2	3	4	5	6
DBEU.10	29.0	32.0	33.8	35.0	36.0	36.8	2.8	5.6	8.4	11.2	14	16.8
DBEU.15	27.0	30.0	31.8	33.0	34.0	34.8	2.2	4.4	6.6	8.8	11	13.2

GELUIDSNIVEAU 1 UNIT dB(A)		
Type	Comfort	Boost
DBEU.10	29	35
DBEU.15	27	31

Nagalmtijd RT60 0.6 s
Referentievertrek V_1 80m³
Referentiedruk P_0 2.10⁻⁵Pa

MEERDERE TOESTELLEN MET HETZELFDE GELUIDSNIVEAU IN EEN RUIMTE	
Aantal [dB(A)]	Correctie [dB(A)]
2	+ 3.0
3	+ 4.8

$P_2 = P_1 + 10 \log n$
 P_1 = geluidsniveau één toestel
 P_2 = te berekenen geluidsdruk
 n = aantal toestellen

ANDER LOKAALVOLUME	
Inhoud m ³	Correctie [dB(A)]
80	0
150	- 2.7
200	- 4.0
250	- 4.9
300	- 5.7
350	- 6.4
400	- 7.0
500	- 8.0
600	- 8.8

Berekening geluidsdruk voor andere lokaalinhoud

$P_2 = P_1 - 10 \log \frac{V_2}{V_1}$
 P_1 = geluidsdruk tabel
 P_2 = te berekenen geluidsdruk
 V_1 = inhoud referentielokaal (80m³)
 V_2 = inhoud ander lokaal

ANDERE NAGALMTIJD	
Nagalmtijd (c) T2	Correctie [dB(A)]
2.5	+ 6.2
2.0	+ 5.2
1.5	+ 4.0
1.0	+ 2.2

$P_2 = P_1 - 10 \log \frac{T_2}{T_1}$
 P_1 = geluidsdruk tabel
 P_2 = te berekenen geluidsdruk
 T_1 = nagalmtijd referentievertrek ($T_1 = 0.6$ s)
 T_2 = nagalmtijd ander lokaal

WANDINBOUW - DRUKVERLIEZEN

DRUKVERLIES TYPE 10

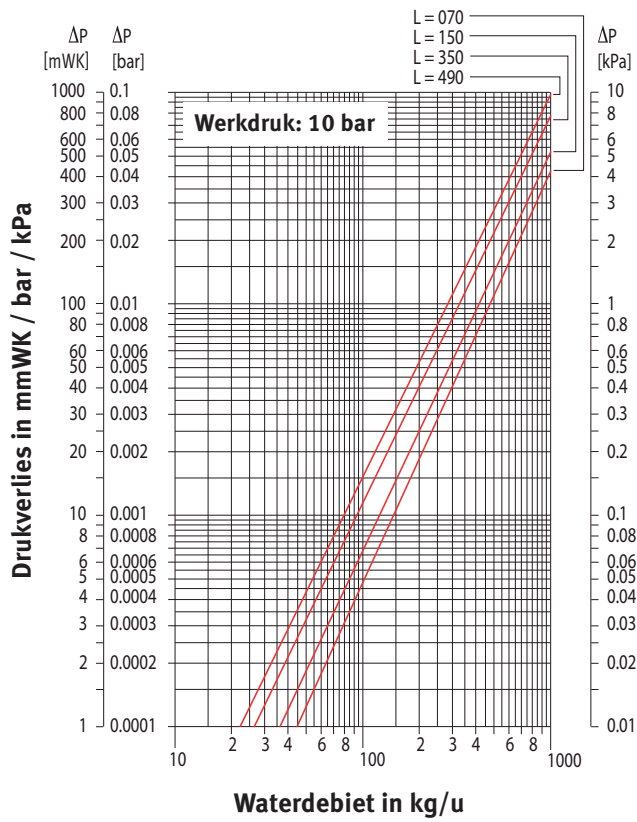

DRUKVERLIES TYPE 11

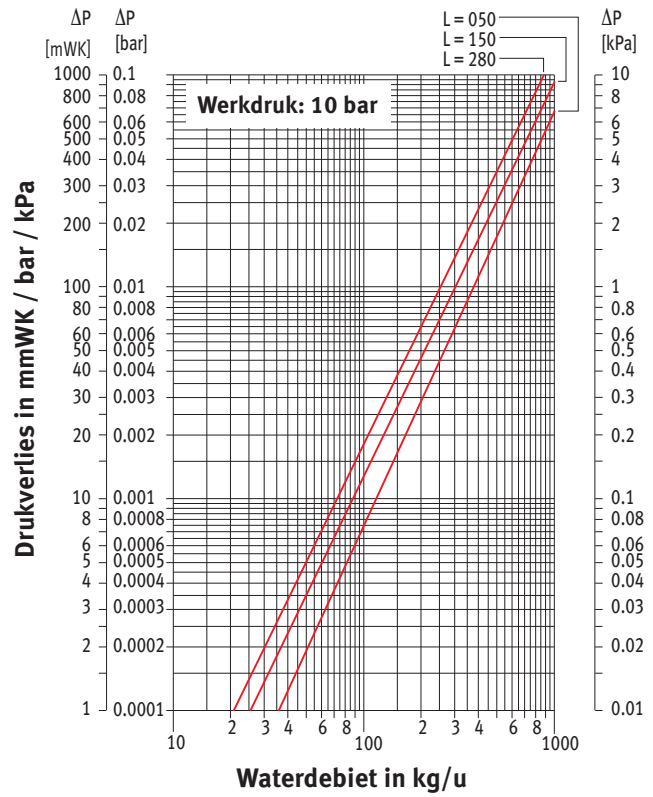

DRUKVERLIES TYPE 15

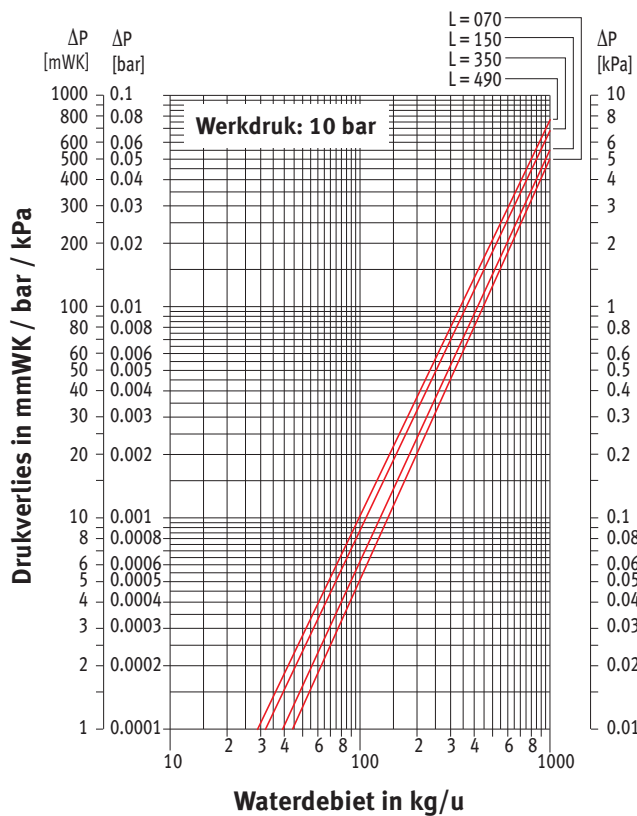

DRUKVERLIES TYPE 16

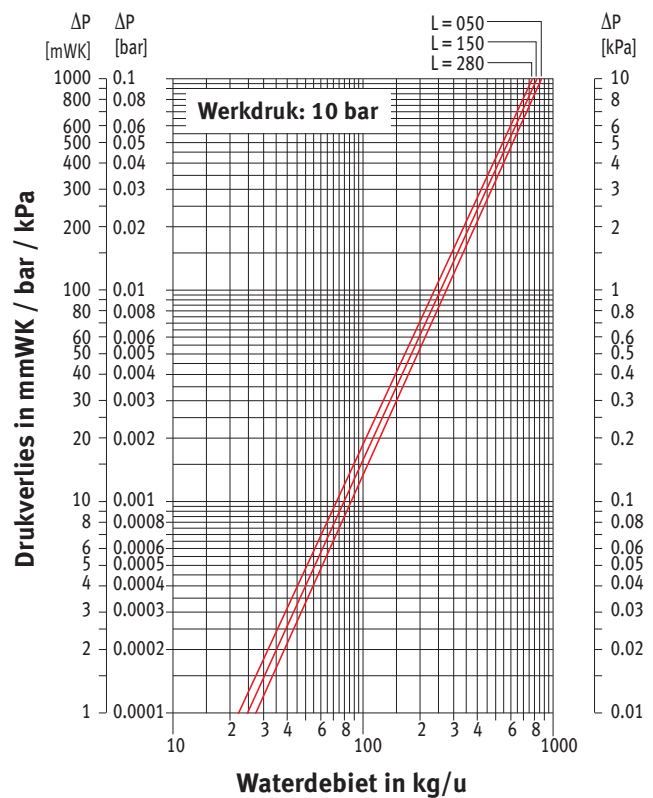

WANDINBOUW ■ DRUKVERLIEZEN

DRUKVERLIES TYPE 20

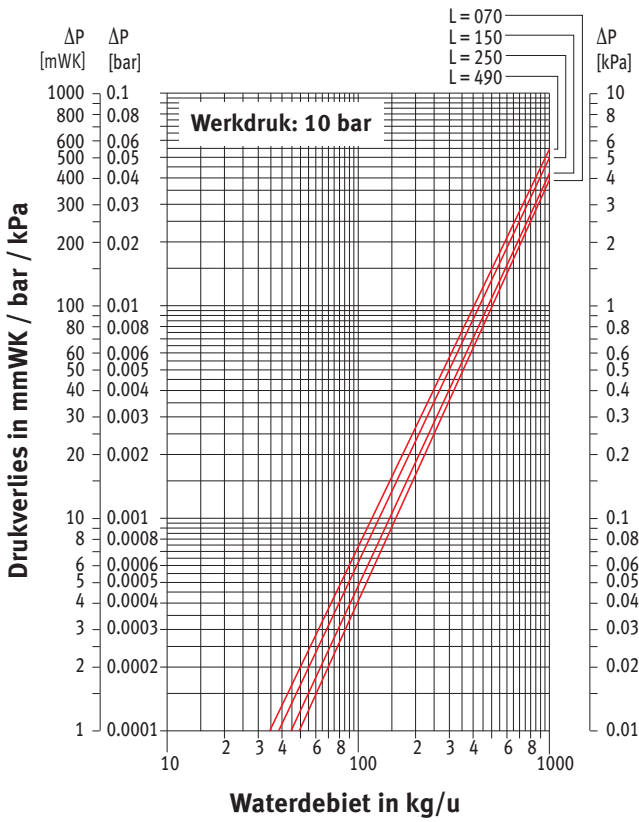

DRUKVERLIES TYPE 21

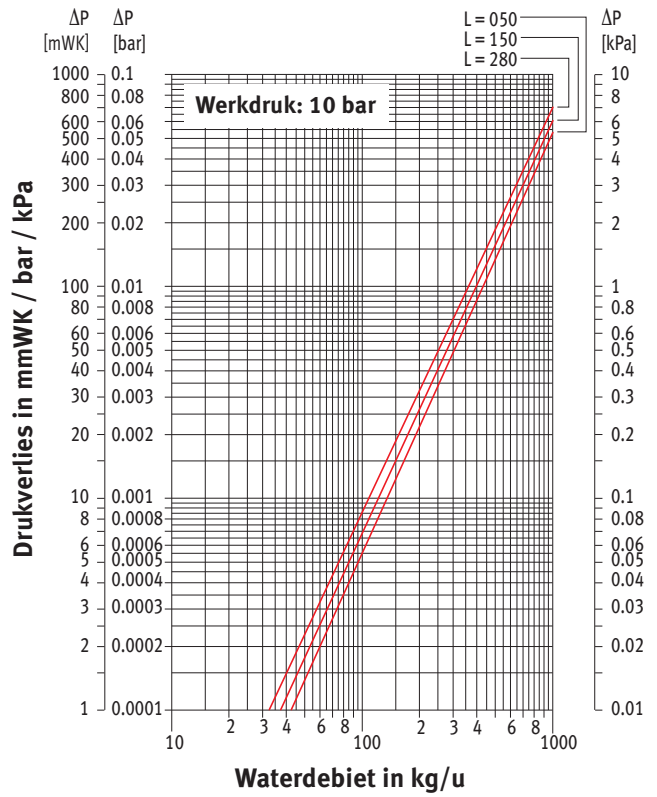

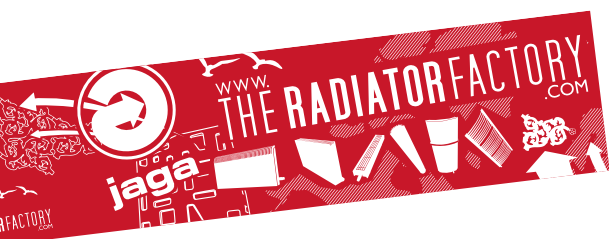

Jaga N.V.
Verbindingslaan 16
B-3590 Diepenbeek

Tel.: +32 (0)11 29 41 11
Fax: +32 (0)11 32 35 78
E-mail: info@jaga.be

Aangezien productontwikkeling een continu proces is, zijn alle
vermelde gegevens onder voorbehoud van wijzigingen.