

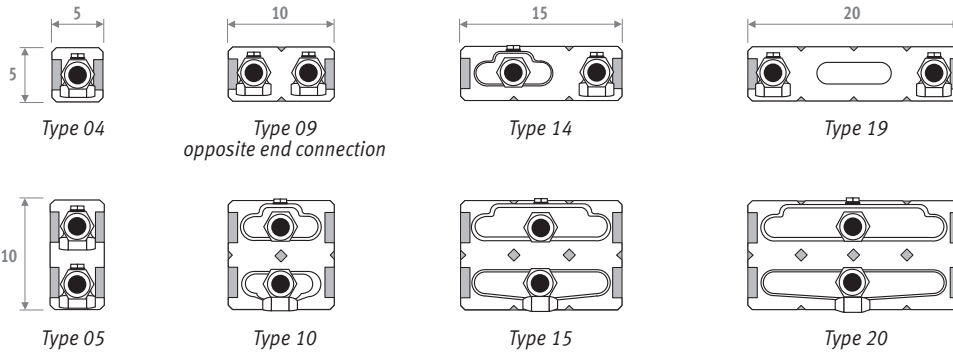

jaga

MINI CANAL
Technical information

MINI CANAL - OVERVIEW HEAT EXCHANGERS



Weight and water content without packaging or options.

WEIGHT IN KG/METRE

Width	H 009	011	014	019
14	4.60	5.00	5.70	---
18	5.01	5.42	---	---
26	5.80	6.24	7.77	9.25
34	7.05	7.52	9.51	11.06
42	8.29	8.80	11.28	12.89

Average weight in kg/metre for the complete unit, including frame and grille.

WATER CONTENT IN LITRE / METRE

Width	H 009	011	014	019
14	0.16	0.16	0.32	---
18	0.32	0.32	---	---
26	0.32	0.32	0.65	0.65
34	0.48	0.48	0.98	0.98
42	0.66	0.66	1.32	1.32

GRILLES WEIGHT IN KG/METRE

Finish	Width	12.8	16.8	24.8	32.8	40.8
	Width duct	14	18	26	34	42
- Roll-up Designo merbau/merbau varnished		2.18	3.00	3.52	3.98	4.67
- Roll-up Designo oak/oak varnished		1.59	2.03	2.69	3.34	3.90
- Roll-up Designo beech/beech varnished		1.50	1.90	2.50	3.10	3.60
- Roll-up merbau/merbau varnished		2.15	2.70	3.03	3.35	4.05
- Roll-up oak/oak varnished		1.48	1.71	2.15	2.61	3.12
- Roll-up beech/beech varnished		1.40	1.60	2.00	2.42	2.88
- Roll-up alu natural/black/brown/brass		1.21	1.38	2.07	2.76	3.45
- Roll-up grille natural Accordion		2.80	3.45	4.85	5.50	7.55
- Roll-up stainless steel		2.18	2.86	4.22	5.58	6.94
- Rigid Designo alu natural/black/brown/brass/lacquered		1.60	2.10	3.20	4.10	5.00
- Rigid alu natural/black/brown/brass/lacquered		1.55	2.20	2.50	3.15	3.75
- Rigid Pebbles		2.20	2.70	3.65	4.60	5.60

MAXIMUM GRILLE LOADINGS

- **Roll-up wood and aluminium grille:** concentrated load in kg in the centre of the grille up to 2 mm deflection.
- **Rigid grilles:** concentrated load in the centre of the transverse section up to 2 mm deflection.
- **Pebbles:** max. 100 kg per tile

concentrated load in kg

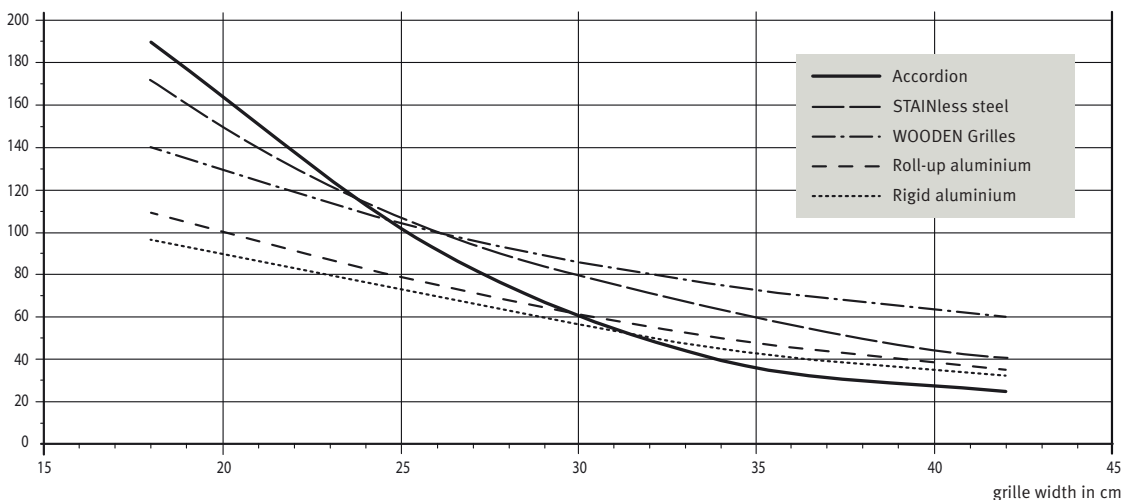

CORRECTION FACTORS ▪ MINI CANAL

AVERAGE CORRECTION FACTORS ACCORDING TO EN442 - 75/65/20°C

Tv	Tl	Tr	25	30	35	40	45	50	55	60	65	70	75	80	85
90	18		0.45	0.58	0.69	0.79	0.89	0.98	1.07	1.16	1.24	1.34	1.41	1.49	1.56
	20		0.38	0.52	0.63	0.74	0.83	0.92	1.01	1.10	1.18	1.28	1.35	1.43	1.50
	22		0.30	0.46	0.57	0.68	0.78	0.87	0.96	1.04	1.13	1.22	1.30	1.37	1.44
	24		0.20	0.39	0.52	0.62	0.72	0.81	0.90	0.99	1.07	1.15	1.24	1.31	1.38
85	18		0.42	0.54	0.65	0.75	0.84	0.93	1.01	1.10	1.20	1.27	1.34	1.41	
	20		0.36	0.49	0.59	0.69	0.79	0.87	0.96	1.04	1.12	1.21	1.28	1.35	
	22		0.28	0.42	0.54	0.64	0.73	0.82	0.90	0.99	1.06	1.15	1.22	1.30	
	24		0.19	0.36	0.48	0.58	0.68	0.76	0.85	0.93	1.01	1.10	1.17	1.24	
80	18		0.39	0.51	0.61	0.70	0.79	0.88	0.96	1.04	1.12	1.20	1.27		
	20		0.33	0.45	0.56	0.65	0.74	0.82	0.90	0.98	1.07	1.14	1.21		
	22		0.26	0.39	0.50	0.60	0.68	0.77	0.85	0.93	1.01	1.08	1.15		
	24		0.17	0.34	0.45	0.54	0.63	0.72	0.80	0.87	0.96	1.03	1.10		
75	18		0.37	0.47	0.57	0.66	0.74	0.82	0.90	0.99	1.05	1.12			
	20		0.30	0.42	0.52	0.61	0.69	0.77	0.85	0.93	1.00	1.07			
	22		0.24	0.36	0.46	0.55	0.64	0.72	0.79	0.88	0.95	1.01			
	24		0.16	0.31	0.41	0.50	0.59	0.67	0.74	0.83	0.89	0.96			
70	18		0.34	0.44	0.53	0.61	0.69	0.77	0.85	0.92	0.99				
	20		0.28	0.39	0.48	0.56	0.64	0.72	0.80	0.87	0.93				
	22		0.22	0.33	0.43	0.51	0.59	0.67	0.74	0.81	0.88				
	24		0.14	0.28	0.38	0.46	0.54	0.62	0.69	0.76	0.83				
65	18		0.31	0.40	0.49	0.57	0.64	0.71	0.79	0.85					
	20		0.25	0.35	0.44	0.52	0.59	0.66	0.74	0.80					
	22		0.19	0.30	0.39	0.47	0.54	0.61	0.69	0.75					
	24		0.12	0.25	0.34	0.42	0.50	0.57	0.64	0.70					
60	18		0.28	0.37	0.45	0.52	0.59	0.66	0.73						
	20		0.23	0.32	0.40	0.47	0.54	0.62	0.68						
	22		0.17	0.27	0.35	0.43	0.50	0.57	0.63						
	24		0.11	0.23	0.31	0.38	0.45	0.52	0.58						
55	18		0.25	0.33	0.40	0.47	0.55	0.60							
	20		0.20	0.29	0.36	0.43	0.50	0.56							
	22		0.15	0.24	0.32	0.38	0.45	0.51							
	24		0.09	0.20	0.27	0.34	0.40	0.47							
50	18		0.22	0.30	0.36	0.43	0.49								
	20		0.18	0.25	0.32	0.38	0.44								
	22		0.13	0.21	0.28	0.34	0.40								
	24		0.08	0.17	0.24	0.30	0.36								
45	18		0.19	0.26	0.32	0.38									
	20		0.15	0.22	0.28	0.34									
	22		0.11	0.18	0.24	0.30									
	24		0.06	0.14	0.20	0.26									
40	18		0.16	0.22	0.28										
	20		0.12	0.18	0.24										
	22		0.09	0.15	0.20										
	24		0.05	0.12	0.17										
35	18		0.13	0.19											
	20		0.10	0.15											
	22		0.07	0.12											
	24		0.03	0.09											
30	18		0.10												
	20		0.07												
	22		0.04												
	24		0.02												

The indicated outputs with $\Delta T 50$ and $\Delta T 60$ are the exact outputs. $\Delta T 50$ output measured in accordance with EN 442 and $\Delta T 60$ output calculated according to EN 442. An average correction factor is given in this table for all other ΔT outputs, applicable for all dimensions.

MINI CANAL - PRESSURE DROP

PRESSURE DROP TYPE 04 OPPOSITE END CONNECTION

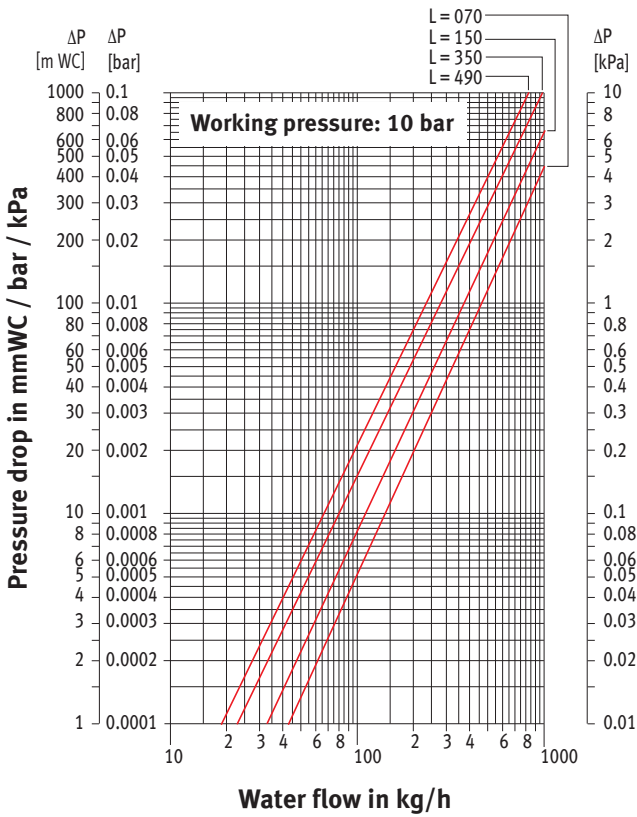

PRESSURE DROP TYPE 05

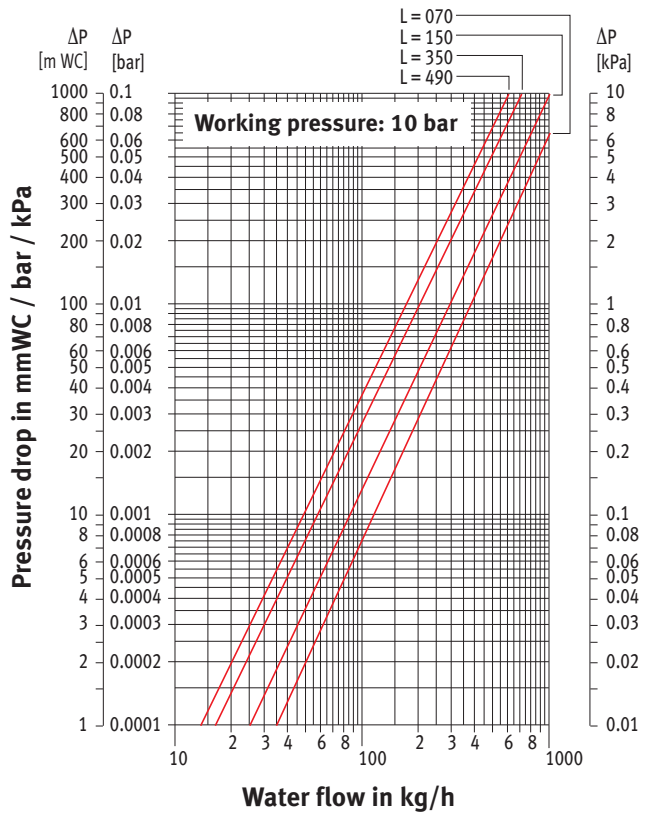

PRESSURE DROP TYPE 09

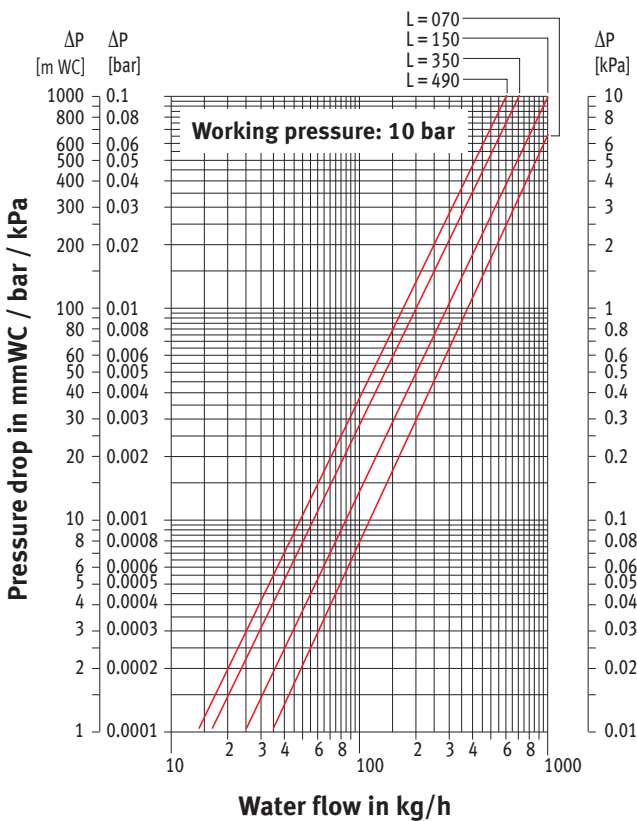

PRESSURE DROP TYPE 10

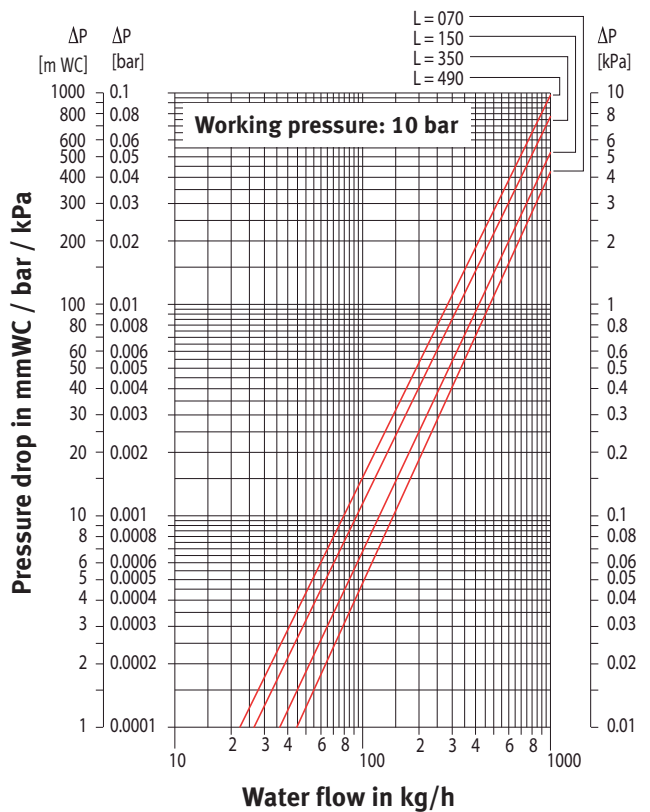

PRESSURE DROP - MINI CANAL

PRESSURE DROP TYPE 14

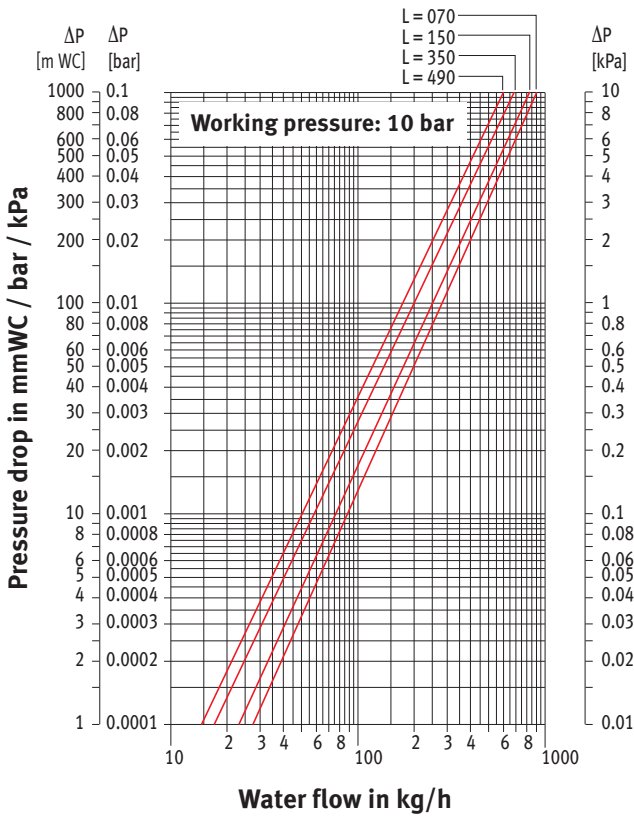

PRESSURE DROP TYPE 15

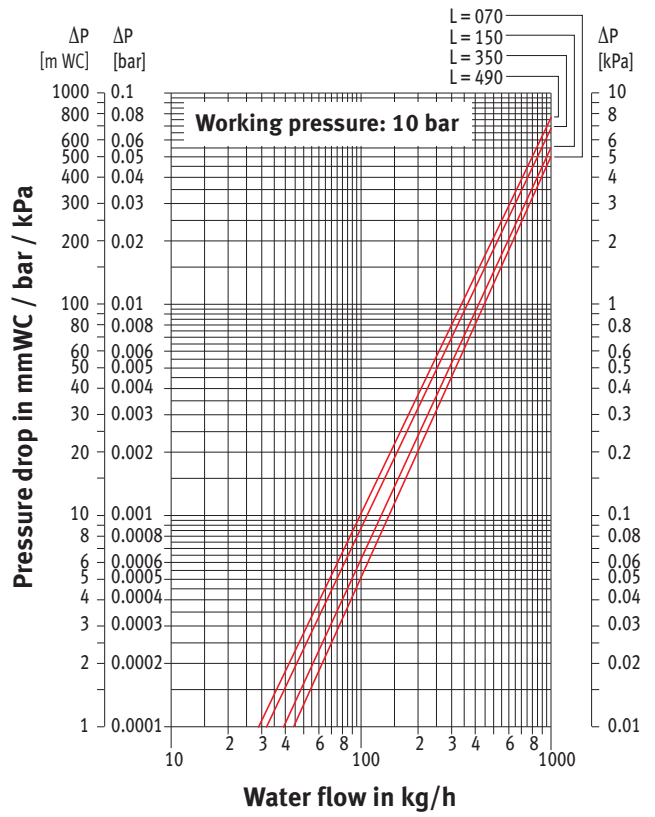

PRESSURE DROP TYPE 19

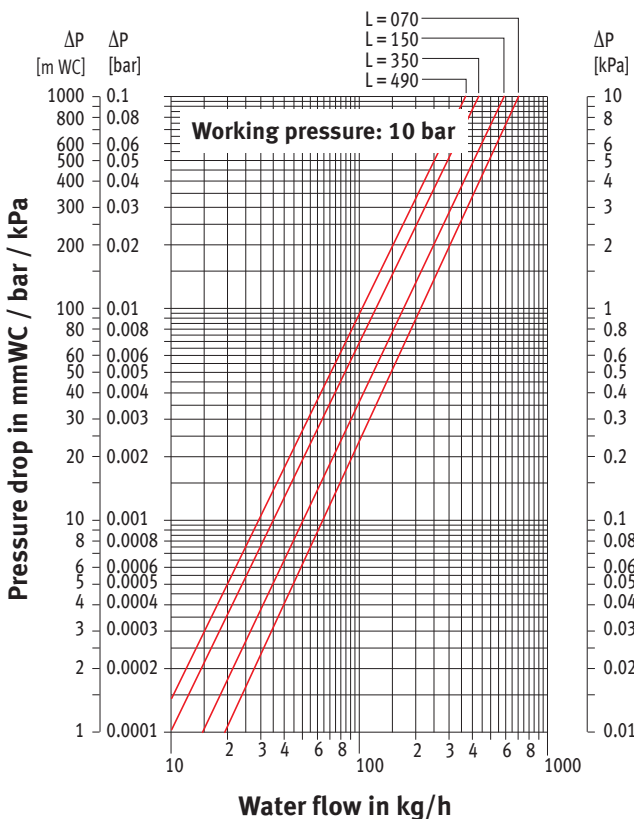

PRESSURE DROP TYPE 20

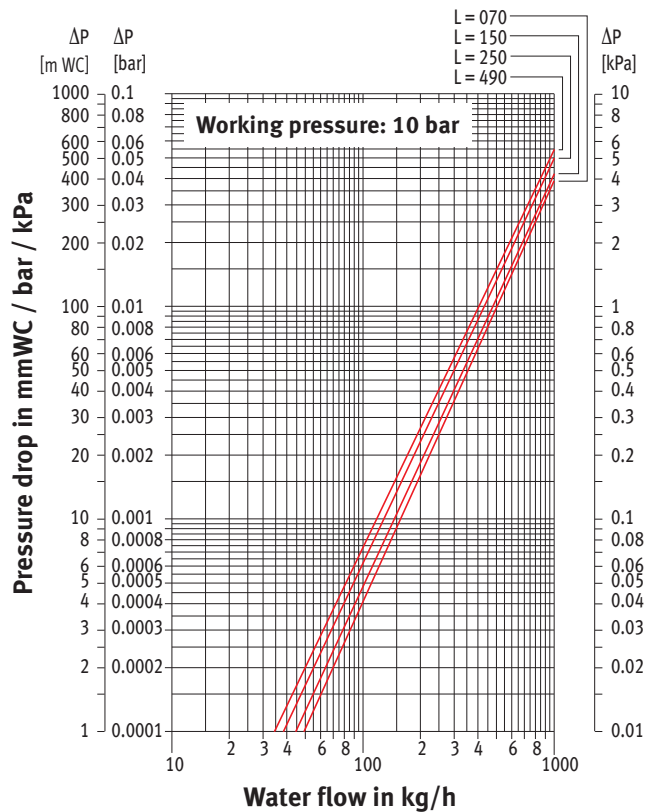

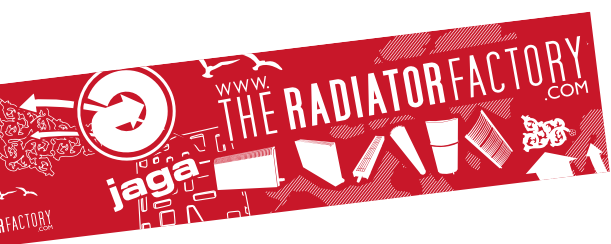

Jaga International
Verbindingslaan 16
B-3590 Diepenbeek

Tel.: +32 11 29 41 12
Fax: +32 11 29 41 60
E-mail: export@jaga.be
www.jaga.be

The information in this price list is correct at the time of printing.
Jaga reserves the right to change product specification at any time in
line with our policy of continuous improvement and innovation.