

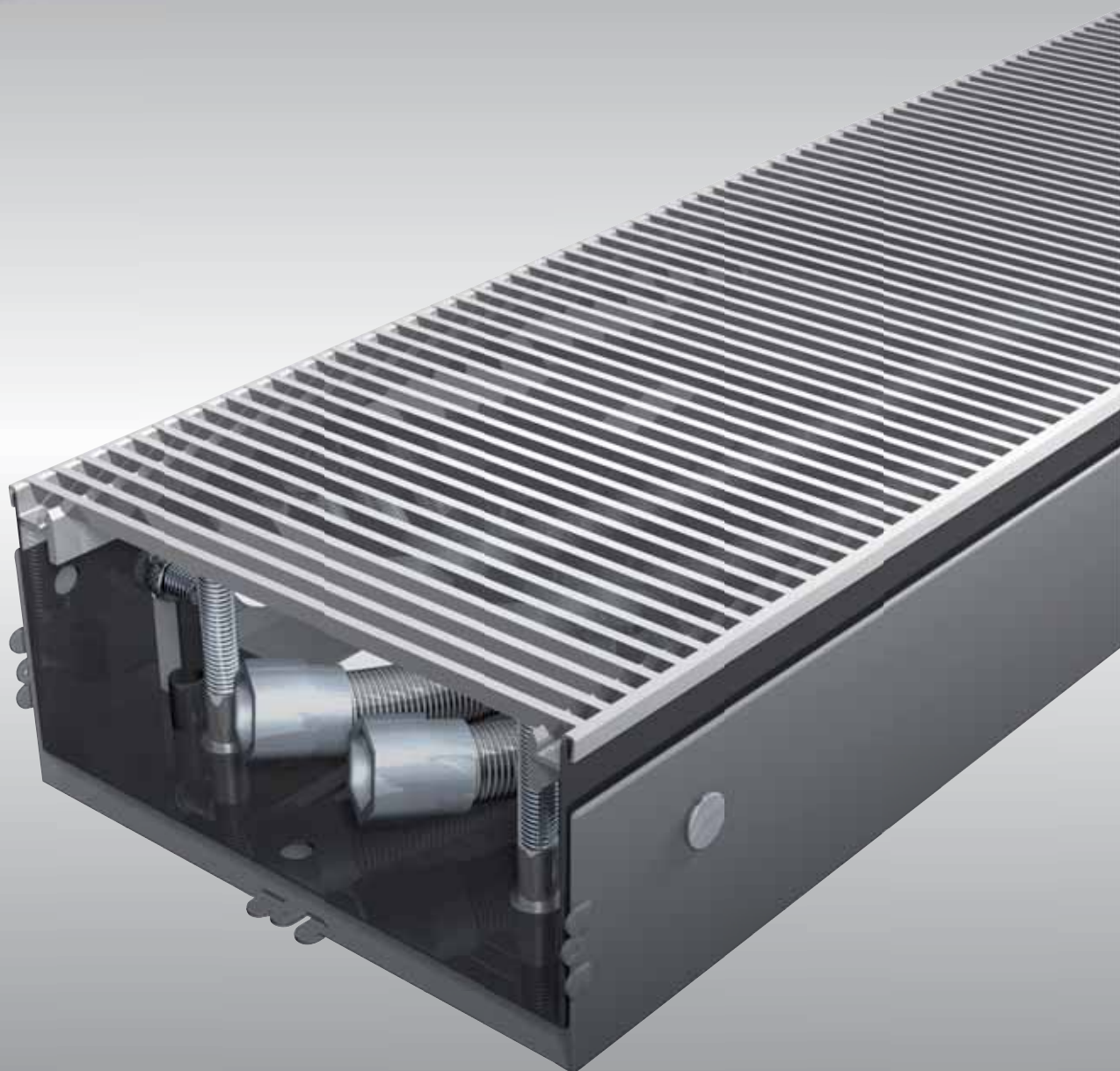

jaga



*TOP
PERFORMERS*

MICRO CANAL

€ 2019.EX



MICRO CANAL

Maximum warmth, minimum dimensions

The latest Jaga trench heating solution is only 6 cm high and 13 cm wide. With small, but powerful dynamic Low-H₂O heat exchangers and super-quiet fans that are no wider than a thermostatic radiator valve, it creates immense power. Micro Canal combines minimalist aesthetics and architectural freedom with a power that breaks all temperature records! Micro Canal integrates harmoniously with any interior. This provides every architect, designer or engineer the greatest possible design freedom on any project without making any compromises for the heating system.

By using **the latest EC motors**, Micro Canals consume up to 50% less electricity than traditional motors



TOP
PERFORMERS

MICRO CANAL



MICRO CANAL



DIMENSIONS (in cm)

Inner casing

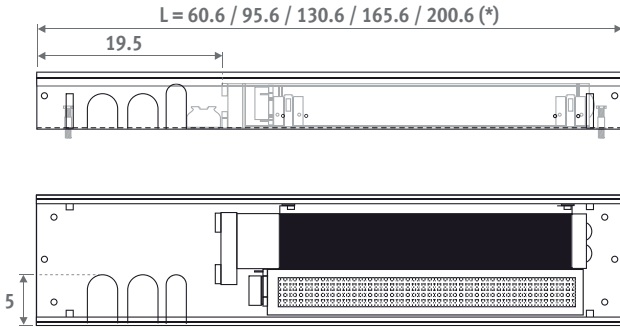

(*) In case of through-mounting, do not install the intermediate tops. Reduce length by 3 mm for each top.

Outer casing

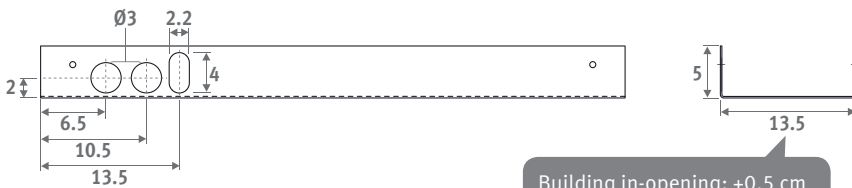

Building in-opening: +0.5 cm

ORDERING CODE

code	height	length	width	grille
MIRF .	006	060	14	./SSS
<i>fill in grille code</i>				

STANDARD DELIVERY

- stainless steel grille
- outer casing with anchorage elements
- polyethylene-protective mounting block(s) and three connection holes on the left hand side
- pre-assembled internal duct with stainless steel grille support
- tangential activator(s) 24 VDC and integrated stainless steel filter
- dynamic heat exchanger with flexible 1/2" stainless steel connectors, length 15 cm
- height adjustment with fine adjustment for alignment with the finished floor.
- automatic activator on/off switch by means of temperature sensor

With energy efficient EC motor

HYDRAULIC CONNECTION

- one-sided 2-pipe connection on the left
- always install Micro Canal with the heat exchanger on the window or wall side
- 2 x 1/2" stainless steel hose included
- allow extra space for curtains, in between the window and the Micro Canal.
- The heat exchanger must always be kept accessible for maintenance purposes
- if the appliance is not mounted flat on the floor, the space between the bottom of the appliance and the floor should be filled with a stable filler material.

ELECTRIC CONNECTION

- clamp connector for electrical connection 24 VDC to the left, to be connected via external power supply. Install a thermostat with a potential-free contact to control the water supply with the help of a zone valve. Micro Canal automatically switches on the activators via a temperature sensor.

COMPOSITION

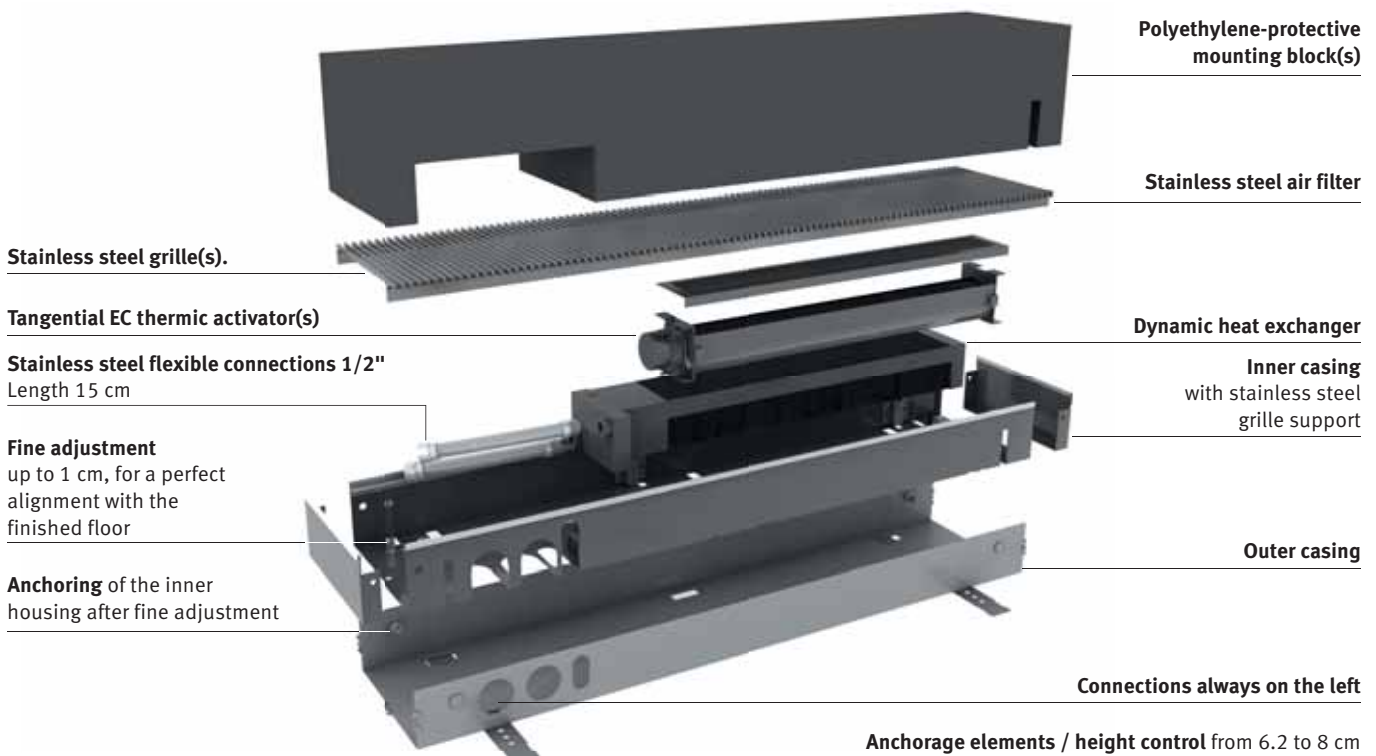

MICRO CANAL

MIRE.HHH LLL BB/XXX



	HEATING			ACTI-VATORS	SOUND PRESSURE*	POWER CON-SUMPTION	AIR FLOW	WATER FLOW	MIRE.HHH LLL BB/XXX	
	Watts 75/65/20°C	Watts 55/45/20°C	Watts 35/30/20°C						€ /SSS	€ /SSC/XXX
H L B				quantity	dB(A)	Watts	<i>with clean filters</i> m³/h	litre/h		
006 060 14	390	234	98	1	18.0	1.6	29.3	34	649,00	714,00
095	780	468	195	1	21.0	1.9	58.5	67	951,80	1046,80
130	1170	702	293	1	22.8	2.2	88.0	101	1271,00	1398,20
165	1560	936	390	2	24.0	3.1	117.0	134	1596,00	1755,60
200	1950	1170	488	2	25.0	3.5	146.5	168	1909,30	2100,20

* With an assumed room attenuation of 8 dB(A) / content of the room 75 m³ / reverberation time 0.5 sec. / measured at 1 m height and 2 m from the appliance.

Correction factors & pressure drop: see "Technical info" chapter

RECOMMENDED COMBINATIONS

	Heating
Product	Micro Canal
Power supply	Power supply: ordering code 37603.010002
Connection set	Connection set 92 with 2 lockshields CODY.LOA.00.3,.. <i>(fill in sleeve coupling code: see p. 312)</i>

OVERVIEW GRILLES

Stainless steel grilles



SSS
stainless steel

Stainless steel grilles lacquered

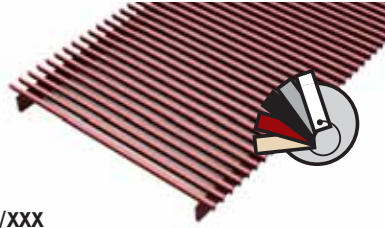

SSC/XXX
stainless steel lacquered

To ensure perfect adherence of the lacquer coating, an extremely wear-resistant and UV-resistant polyester lacquer coating of the highest quality is used. Only in glossy (code 2..) and special colours 006, 005, 026, 028.

STANDARD DELIVERY

ASSEMBLY & PROTECTION BLOCK



Install the polyethylene protective block(s) as protection on the construction site.

DESIGN GRILLES

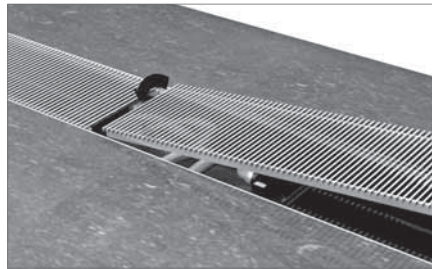

Continuous design grille of stainless steel grilles.

HEIGHT CONTROL

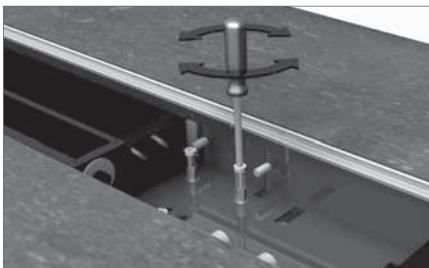

Double height adjustment by means of the anchoring on the outer casing and by fine adjustment with the bolts in the inner housing (adjustable from 6.2 to 8 cm).

FLEXIBLE CONNECTION

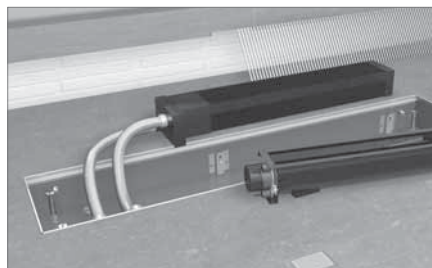

Stainless steel flexible hoses (15 to 25 cm), enabling the internal mechanism to be removed completely for easy cleaning.

MICRO CANAL - OPTIONS

POWER SUPPLY DIN-RAIL MONTAGE



The guarantee is only valid if the original Jaga power supply is used.

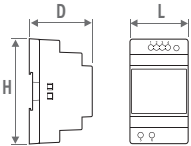

CODE	H	L	D
7990.054	9.0	3.5	5.9
7990.055	9.0	5.3	5.9
7990.056	9.0	7.0	5.9
7990.053	12.5	12.6	8.3

- for DIN-rail or wall mounting
- conformity UL60950 / UL508 / IEC 60950-1 / TUV EN61558-2-16 / Class 2
- output voltage 24 VDC
- input voltage 100 - 240 VAC
- screw connection
- LED indicator

CODE	Output Watts	Output current A	€
7990.054	36	1.5	36,90
7990.055	60	2.5	49,80
7990.056	92	3.9	71,80
7990.053	240	10	157,50

Required power = sum of the power consumption of the devices

MAXIMUM CABLE LENGTH

In function of the number of devices: see <http://www.jaga.com/en/products/trench-heating/micro-canal>

SEPARATE POWER SUPPLY

Waterproof power supply 24 VDC/30 Watt with waterproof cable gland.



Not suitable for installation in the floor duct.

- conformity: UL60950 - EN 60950 / Class 2
- output voltage 24 VDC
- input voltage 100 - 240 VAC
- dimensions L 14.5 x B 4.5 x H 3.0 cm

CODE	Output Watts	Output current A	€
37603.010002	30	1.25	71,80

CONNECTION SET WITH 2 LOCKSHIELDS M24 90°



set 92

CODY.LOA.00.3... € **40,70**

fill in sleeve coupling code: see below

SLEEVE COUPLINGS M24

PRECISION METAL TUBE

CODE	Tube Ø
110	10/1
112	12/1
114	14/1
115	15/1
116	16/1
118	18/1

SYNTHETIC TUBE

CODE	Tube Ø
212	12/2
214	14/2
219	16/1.5
216	16/2
217	17/2
218	18/2

RPE/ALU TUBE

CODE	Tube Ø
314	14/2
316	16/2
326	16/2.2
318	18/2

STEEL TUBE FOR C.H.

CODE	Tube Ø
501	M24 x 1/2"
503	M24 x 3/8"

Surcharge: **2,50 €**

VALVE UNIT



- length 35 cm
- motorised thermostatic valve 24 VDC with lockshield
- outer casing with height control
- inner casing with stainless steel grille support
- stainless steel grille, natural coloured or lacquered
- protection block

CODE	€
7522.00603514/SSS/VC	353,00
7522.00603514 /SSC/... /VC	388,60

fill in colour code



Order sleeve couplings M24: see p. 154

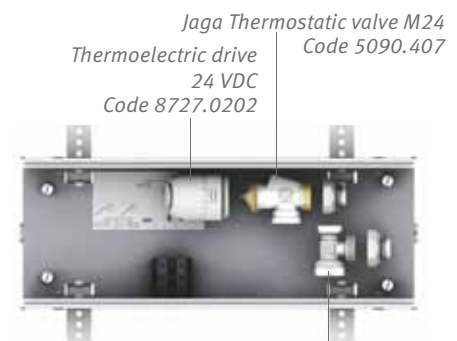

Dimensions of the valves, see "Connection sets & valves" chapter

JAGA TWO-WAY VALVE AND THERMOELECTRIC DRIVE 230 VAC



- only for mounting on the distributor, not in the Micro Canal!
- with varistor to protect against power surge
- with position indicator (open/closed)
- sleeve couplings have to be provided by the installer

CODE	Description	€
7990.409	180° - G1/2" F / NG 230V 2Watts	83,30
7990.411	180° - G3/4" F / NG 230V 2Watts	94,00

MICRO CANAL - OPTIONS



EMPTY HOUSING

To fill open spaces for a continuous installation.



- outer casing with height control
- inner casing with stainless steel grille support
- stainless steel grille, natural coloured or lacquered
- protection block(s)
- 2 head pieces

empty housing with stainless steel grille

CODE	L	€
7522.00603514/SSS	35	257,10
7522.00606014/SSS	60	344,00
7522.00609514/SSS	95	486,50
7522.00613014/SSS	130	638,00
7522.00616514/SSS	165	785,10
7522.00620014/SSS	200	937,70

empty housing with lacquered stainless steel grille

CODE	L	€
7522.00603514/SSC/ ...	35	282,50
7522.00606014/SSC/ ...	60	406,40
7522.00609514/SSC/ ...	95	576,90
7522.00613014/SSC/ ...	130	759,40
7522.00616514/SSC/ ...	165	937,70
7522.00620014/SSC/ ...	200	1119,00

enter colour code

CORNER PIECE



- aluminium cover plate in stainless steel effect (SSS), or lacquered in other Jaga colours (SSC)
- outer casing with anchorage elements
- polyethylene-protective mounting block(s)
- fully assembled inner housing with stainless steel grille support
- height adjustment with fine adjustment for alignment with the finished floor

Outer corner

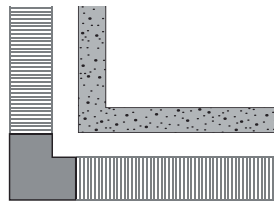

CODE		€
7522.00602014/SSS/02	Natural	405,50
7522.00602014/SSC/.../02	lacquered	421,00

enter colour code

Inner corner

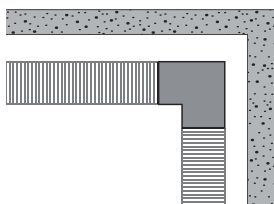

CODE		€
7522.00602014/SSS/01	Natural	405,50
7522.00602014/SSC/.../01	lacquered	421,00

enter colour code

FEET WITH HEIGHT ADJUSTMENT FOR RAISED FLOORS

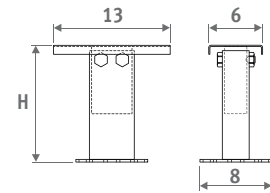

- lacquered in dark grey RAL 7024.
- easy installation by means of "stainless steel spring system"
- 1 set includes 2 height adjusting controls

Number of sets per Micro Canal

L 35 = 1 set
L 60 = 1 set
L 95 = 1 set
L 130 = 2 sets
L 165 = 2 sets
L 200 = 2 sets

CODE	H	€/set
5207.05070000	5 > 7 cm	39,50
5207.08130000	8 > 13 cm	40,70
5207.13230000	13 > 23 cm	43,00
5207.20300000	20 > 30 cm	43,70

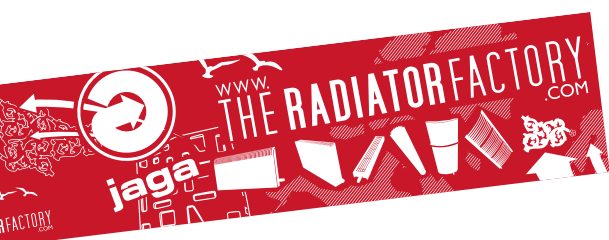

Jaga International
Verbindingslaan 16
B-3590 Diepenbeek

Tel.: +32 (0)11 29 41 12
Fax: +32 (0)11 29 41 60
export@jaga.com

The information in this price list is correct at the time of printing.
Jaga reserves the right to change product specification at any time in line
with our policy of continuous improvement and innovation.
All prices in Euro, exclude VAT. Prices valid from 1st January 2019.
Replaces all existing price lists.