



JAGA PRO - Kv max. 0.60

Montagehandleiding Jaga Pro ventiel tweepijp
 Instructions de montage vanne Jaga Pro bitube
 Montagehinweis Jaga Pro Ventil Zweirohr
 Mounting instructions Jaga Pro valve two pipe

Kv min. 0.03 - max. 0.60 m³/u
 Kv min. 0.03 - max. 0.60 m³/h
 Kv min. 0.03 - max. 0.60 m³/St.
 Kv min. 0.03 - max. 0.60 m³/h

Energy
SAVERS
 LOW-H₂O

Afmetingen
 Dimensions
 Abmessungen
 Dimensions

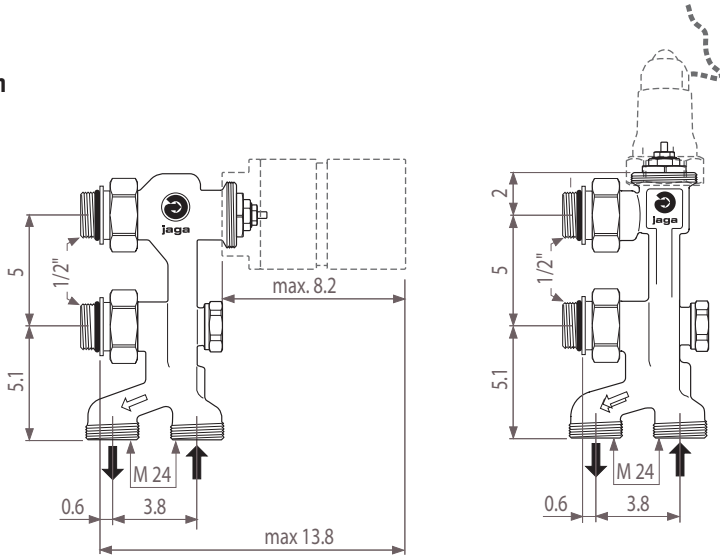

Code / Art.-Nr.

5094.4414 recht - droite Durchgangsform - straight	5094.4411 haaks - équerre Eckform - angled
--	--

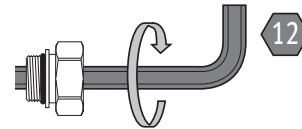

Technische gegevens
 Données techniques

- > Max. watertemperatuur: 120 °C
- > Max. bedrijfsdruk: 10 bar
- > Max. drukval: 0.6 bar i.v.m. geluidsniveau ref. ISO 3743
- > Température max. de l'eau: 120°C
- > Pression de travail max.: 1000 kPa (10 bars)
- > Chute de pression max.: 60 kPa (0.6 bars) par rapport à la norme du niveau sonore réf. ISO 3743.

Technische Daten
 Technical data

- > Max. Wassertemperatur: 120°C
- > Max. Betriebsdruck: 10 bar
- > Max. Druckgefälle: 0.6 bar in Zusammenhang mit dem Geräuschpegel Ref. ISO 3743
- > Maximum water flow temperature: 120 °C
- > Max pressure of system: 10 bar
- > Max pressure drop 0.6 bar complying to the noise standard ISO 3743

Klemkoppelingen M24 x 1.5 mm
 Raccords bicônes M24 x 1.5 mm
 Klemmringverschraubungen M24 x 1.5 mm
 Sleeve couplings M24 x 1.5 mm

Dunwandig metalen buis
 Tube métallique de précision
 Präzisionsmetallrohr
 Precision metal tube

Code / Art.-Nr.	
5094.110	ø M24 x 10/1
5094.112	ø M24 x 12/1
5094.114	ø M24 x 14/1
5094.115	ø M24 x 15/1
5094.116	ø M24 x 16/1
5094.118	ø M24 x 18/1

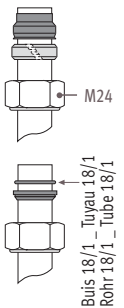

Kunststof buis - Tuyau synthétique
 Kunststoff Rohr - Synthetic tube

Code / Art.-Nr.	
5094.213	ø M24 x 12/1
5094.212	ø M24 x 12/2
5094.214	ø M24 x 14/2
5094.219	ø M24 x 16/1.5
5094.216	ø M24 x 16/2
5094.217	ø M24 x 17/2
5094.218	ø M24 x 18/2

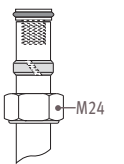

VPE/ALU buis - Tuyau en PER/ALU
 VPE/ALU Rohr - RPE/ALU tube

5094.314	ø M24 x 14/2
5094.316	ø M24 x 16/2
5094.326	ø M24 x 16/2.2
5094.318	ø M24 x 18/2
5094.336	ø M24 x 16/2.2

TECE-buis / tuyau TECE / TECE-Rohr / TECE tube

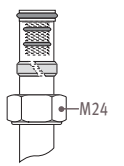

Stalen C.V. buis - Tuyau en acier
 Eisenrohr - Steel tube for C.H.

Code / Art.-Nr.	
5094.501	ø M24 x 1/2"
5094.503	ø M24 x 3/8"

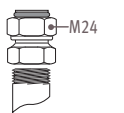

Opties / Options / Optionen

Aansluiting naar de wand met bochten
 Raccordement vers le mur avec courbes
 Anschluss zur Wand mit Bogen
 Connection to the wall with curves

Code / Art.-Nr.
5095.020

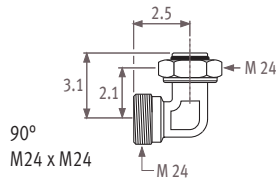

Pro Sleutel
 Clé Pro
 Pro Schlüssel
 Pro key

Code / Art.-Nr.
5090.1120

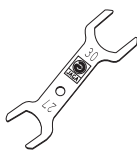

- > Gereedschap voor eenvoudige montage van het Pro ventiel
- > Outillage pour faciliter le montage de la vanne Jaga Pro
- > Werkzeug zur Vereinfachung der Montage des Jaga Pro-Ventils
- > Tool for easy mounting of the Jaga Pro valve

Thermostaatkop
 Tête de vanne thermostatique
 Thermostatkopf
 Thermostatic head

Code / Art.-Nr.

5090.1125 (Type JW)
5090.1126 (Type JB)
5090.1110 (Type DW)
5090.1111 (Type DC)
5090.1119 (Type JC)

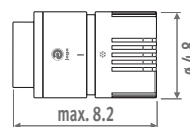

JW 5090.1125 (RAL 9016)
 wit / blanc / weiss / white

JB 5090.1126 (RAL 9005)
 zwart / noir / schwarz / black

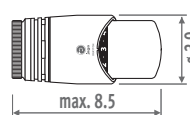

DW 5090.1110
 chrome - wit / chrome - blanc
 chromiert - weiss / chrome - white

DC 5090.1111
 chrome / chromiert

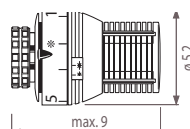

JC 5090.1119
 zilver / argent / silver / silver

Hydraulische instelling - Réglage hydraulique - Hydraulische Einstellung - Hydraulic adjustment

		Instelling - Réglage - Einstellung - Setting													KvS
		*	*	**	*	**	*	*	*	**	*	*	*	*	
		I	II	III	IV	V	VI	VII	VIII	IX	X	XI	XII	XIII	
	1 Voorinstelling Préréglage Voreinstellung Pre-setting 2 Volledig dicht draaien en 0.5 omwenteling terug openen Complètement fermer et ouvrir à nouveau 0.5 tour Vollständig schliessen und wieder 0.5 Umdrehung öffnen Close completely and open again 0.5 rotation 3 Volledig dicht draaien Complètement fermer Vollständig schliessen Close completely 4 Aantal toeren te openen Nombre de tours à ouvrir Anzahl Umdrehungen zum öffnen Number of rotations to open 5 Open draaien tot voelbare weerstand Ouvrir jusqu'à résistance notable Öffnen bis fühlbaren Widerstand Open till noticeable resistance Kv: $m^3/h/\Delta P=1\text{bar}$ Radiatorvoeding in % - Alimentation radiateurs en % Vorlauf Heizkörper in % - Radiator flow in %	4	4	1	4	2	4	4	4	3	4	4	5	6	6
		X	X	Not applicable	X	Not applicable	X	X	X	Not applicable	X	Niet van toepassing Pas applicable Nicht zutreffend Not applicable			
		X	X	Not applicable	X	Not applicable	X	X	X	Not applicable	X	Niet van toepassing Pas applicable Nicht zutreffend Not applicable			
		3/4	1	Not applicable	1 1/2	Not applicable	1 3/4	2	2 1/2	Not applicable	3	Niet van toepassing Pas applicable Nicht zutreffend Not applicable			
		X	X	Not applicable	X	Not applicable	X	X	X	Not applicable	X	Niet van toepassing Pas applicable Nicht zutreffend Not applicable			
		0.03	0.05	0.07	0.11	0.16	0.17	0.22	0.31	0.32	0.36	0.44	0.51	0.60	1.00
		5	8	11	18	26	28	37	52	53	60	73	85	100	

- * Verstopping mogelijk bij vuile installaties.
- ** Zeer licht gesuis mogelijk bij drukval hoger dan 0.2 bar.
- * Obstruction possible en cas d'installations encrassées.
- ** Très léger bourdonnement possible en cas de chute de pression supérieure à 0.2 bar.
- * Verstopping bei verschmutzten Installationen möglich.
- ** Sehr leichtes Geräusch bei Druckabfall höher als 0.2 bar möglich.
- * Possible stoppage by dirty installations.
- ** An increase in noise level may be experienced if the pressure drop exceeds 0.2 bar.

Voorbeeld:
Verwarmingslichaam 1 kW (Tabel $\Delta T=50$)
 $\Delta T = 10^\circ\text{C}$ (75 - 65 = 10°C)
 $\Delta P = 0.1$ bar (over het ventiel in te stellen)
Regeling VIII: voorinstelling 4 / fijnregeling 2.5 omwentelingen openen

Exemple:
Échangeur de chaleur 1 kW (Table $\Delta T=50$)
 $\Delta T = 10^\circ\text{C}$ (75 - 65 = 10°C)
 $\Delta P = 0.1$ bar (à régler sur la vanne)
Réglage VIII: préréglage 4 / ouvrir le vis régulateur précision de 2.5 tours

Beispiel:
Wärmetauscher 1 kW (Tabelle $\Delta T=50$)
 $\Delta T = 10^\circ\text{C}$ (75 - 65 = 10°C)
 $\Delta P = 0.1$ bar (über das Ventil einzustellen)
Regelung VIII: Voreinstellung 4 / Schraube für Feineinstellung 2.5 Umdrehungen öffnen

Example:
Heat exchanger 1 kW (Table $\Delta T=50$)
 $\Delta T = 10^\circ\text{C}$ (75 - 65 = 10°C)
 $\Delta P = 0.1$ bar (to be regulated over the valve)
Setting VIII: pre-setting 4 / twist off screw for precision adjustment with 2.5 rotations

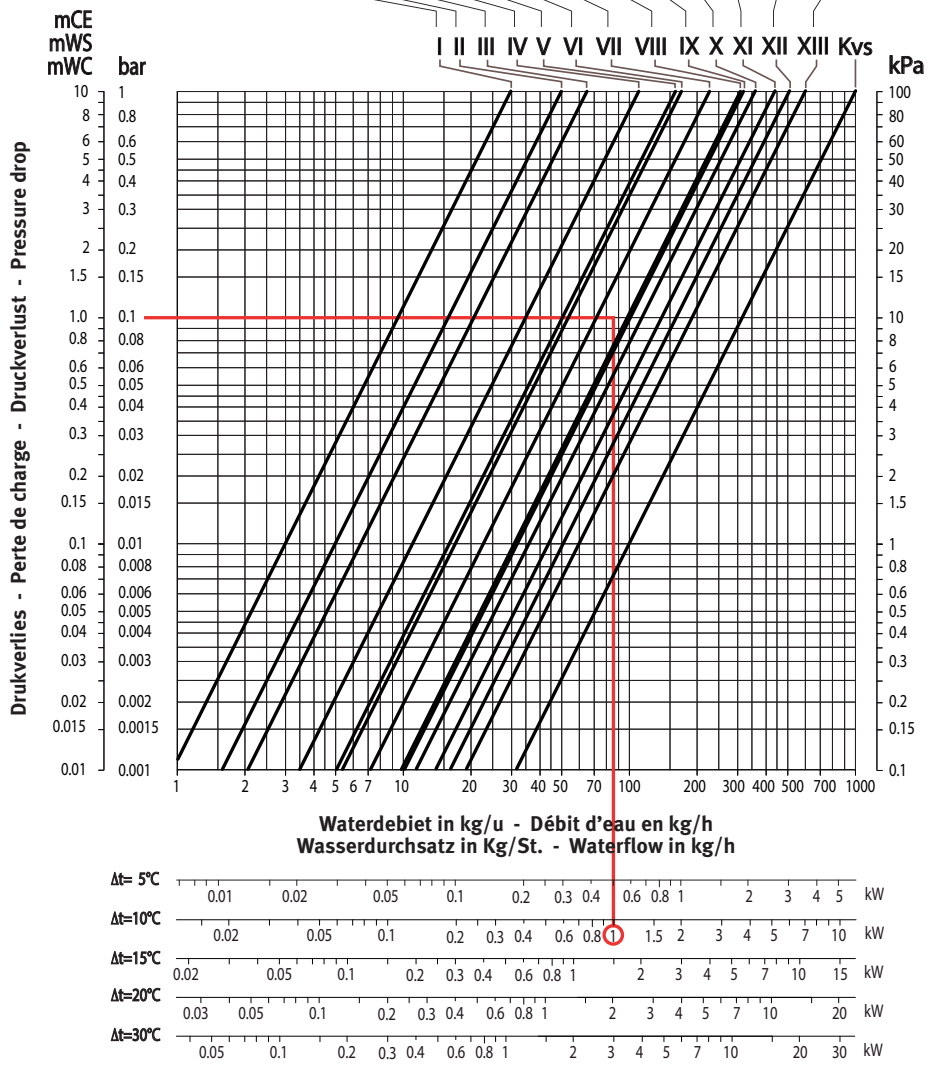

Demontage van de warmtewisselaar Démontage de l'échangeur de chaleur Demontage des Wärmetauschers Unmounting of the heat exchanger

- > Sluit de thermostaatkop (1), sluit de afsluiter (2) en schroef het ventiel los (3). De Kv-instelling blijft behouden.
- > Fermer le thermostatique (1), fermer le pointeau d'isolement (2) et dévisser les écrous (3). La réglage du Kv reste inchangée.
- > Thermostatkopf schliessen (1), Abschluss schliessen (2) und Ventil los-schrauben (3). Die Kv-Einstellung bleibt behalten.
- > Close the TRV (1), close the cut off (2) and unscrew the valve (3). The Kv adjustment remains unchanged.

