



JAGA 3/4" Eurocone_Kv max. 0.60

Energy SAVERS LOW-H2O

Montagehandleiding Jaga ventiel 3/4" Euroconus - standaard Kv
 Instructions de montage vanne Jaga 3/4" Eurocone - Kv standard
 Montagehinweis Jaga Ventil 3/4" Euro-Konus - standard Kv
 Mounting instructions Jaga valve 3/4" Eurocone- standard Kv

Afmetingen Dimensions Abmessungen Dimensions

Code / Art.-Nr.

5090.4407

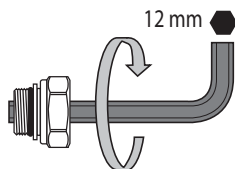
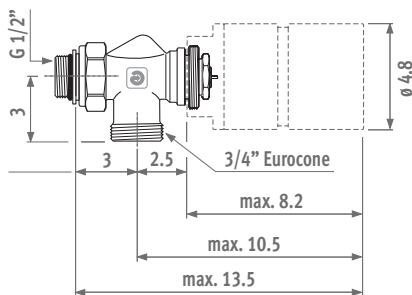

Technische gegevens Données techniques Technische Daten Technical data

- Max. watertemperatuur: 120 °C
- Max. bedrijfsdruk: 10 bar
- Max. drukval: 0.6 bar i.v.m. geluidsniveau ref. ISO 3743

- Température max. de l'eau: 120°C
- Pression de travail max.: 1000 kPa (10 bars)
- Chute de pression max.: 60 kPa (0.6 bars) par rapport à la norme du niveau sonore réf. ISO 3743.

- Max. Wassertemperatur: 120°C
- Max. Betriebsdruck: 10 bar
- Max. Druckgefälle: 0.6 bar in Zusammenhang mit dem Geräuschpegel Ref. ISO 3743

- Maximum water flow temperature: 120 °C
- Max pressure of system: 10 bar
- Max pressure drop 0.6 bar complying to the noise standard ISO 3743

Opties / Options / Optionen

Thermostaatkop Tête de vanne thermostatique Thermostatkopf Thermostatic head

Code / Art.-Nr.

- 5090.1125 (Type JW)
- 5090.1126 (Type JB)
- 5090.1110 (Type DW)
- 5090.1111 (Type DC)
- 5090.1119 (Type JC)

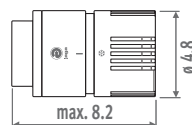

JW (RAL 9016)
5090.1125
wit / blanc / weiss / white

JB (RAL 9005)
5090.1126
zwart / noir / schwarz / black

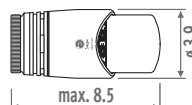

DW
5090.1110
chrome - wit / chrome - blanc
chromiert - weiss / chrome - white

DC
5090.1111
chrome / chromiert

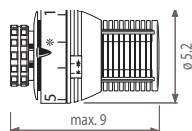

JC
5090.1119
zilver / argent / silber / silver

Klemkoppelingen 3/4" Euroconus Raccords bicônes 3/4" Eurocone Klemringverschr. 3/4" Euro-Konus Sleeve couplings 3/4" Eurocone

Dunwandig metalen buis
Tube métallique de précision
Präzisionsmetallrohr
Precision metal tube

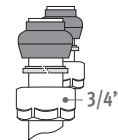

Code / Art.-Nr.

- | | |
|-----------|--------------|
| 5094.2112 | Ø 3/4 x 12/1 |
| 5094.2114 | Ø 3/4 x 14/1 |
| 5094.2115 | Ø 3/4 x 15/1 |
| 5094.2116 | Ø 3/4 x 16/1 |
| 5094.2118 | Ø 3/4 x 18/1 |

Kunststof of VPE/ALU buis
Tuyau synthétique ou PER/ALU
Kunststoff oder VPE/ALU Rohr
Synthetic or RPE/ALU tube

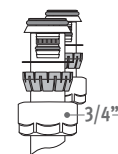

Alleen voor buis 12/2
Seulement pour tuyau 12/2
Nur für Rohr 12/2
Just for tube 12/2

Code / Art.-Nr.

- | | |
|-----------|----------------|
| 5094.2612 | Ø 3/4 x 12/2 |
| 5094.2614 | Ø 3/4 x 14/2 |
| 5094.2616 | Ø 3/4 x 16/2 |
| 5094.2617 | Ø 3/4 x 17/2 |
| 5094.2618 | Ø 3/4 x 18/2 |
| 5094.2615 | Ø 3/4 x 15/2.5 |
| 5094.2619 | Ø 3/4 x 16/1.5 |
| 5094.2620 | Ø 3/4 x 20/2 |

Retourventiel 3/4" Euroconus 90° Raccord de réglage 3/4" Eurocone 90° Rücklaufverschr. 3/4" Euro-Konus 90° Lockshiekd 3/4" Eurocone 90°

Code / Art.-Nr.

5090.4111

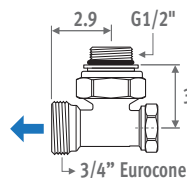

Retourventiel 3/4" Euroconus 180° Raccord de réglage 3/4" Eurocone 180° Rücklaufverschr. 3/4" Euro-Konus 180° Lockshiekd 3/4" Eurocone 180°

Code / Art.-Nr.

5094.4431

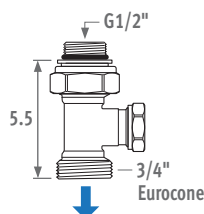

Hydraulische instelling _ Réglage hydraulique _ Hydraulische Einstellung _ Hydraulic adjustment

Voorinstelling _ Préréglage _ Voreinstellung _ Pre-setting:

Kv: m ³ /h/ΔP=1bar	1	2	3	4	5	6	KvS
	0.1	0.2	0.3	0.4	0.5	0.6	0.8
Tweepijp _ Bitube _ Zweirohr _ Two pipe							

Voorbeeld:

Verwarmingssysteem 1 kW (Tabel ΔT = 50)
 ΔT = 10°C (75 - 65 = 10°C)
 ΔP = 0.1 bar (over het ventiel in te stellen)
 Voorinstelling = 3

Exemple:

Échangeur de chaleur 1 kW (Table ΔT = 50)
 ΔT = 10°C (75 - 65 = 10°C)
 ΔP = 0.1 bar (à régler sur la vanne)
 Préréglage = 3

Beispiel:

Wärmetauscher 1 kW (Tabelle ΔT = 50)
 ΔT = 10°C (75 - 65 = 10°C)
 ΔP = 0.1 bar (über das Ventil einzustellen)
 Voreinstellung = 3

Example:

Heat exchanger 1 kW (Table ΔT = 50)
 ΔT = 10°C (75 - 65 = 10°C)
 ΔP = 0.1 bar (to be regulated over the valve)
 Pre-setting = 3

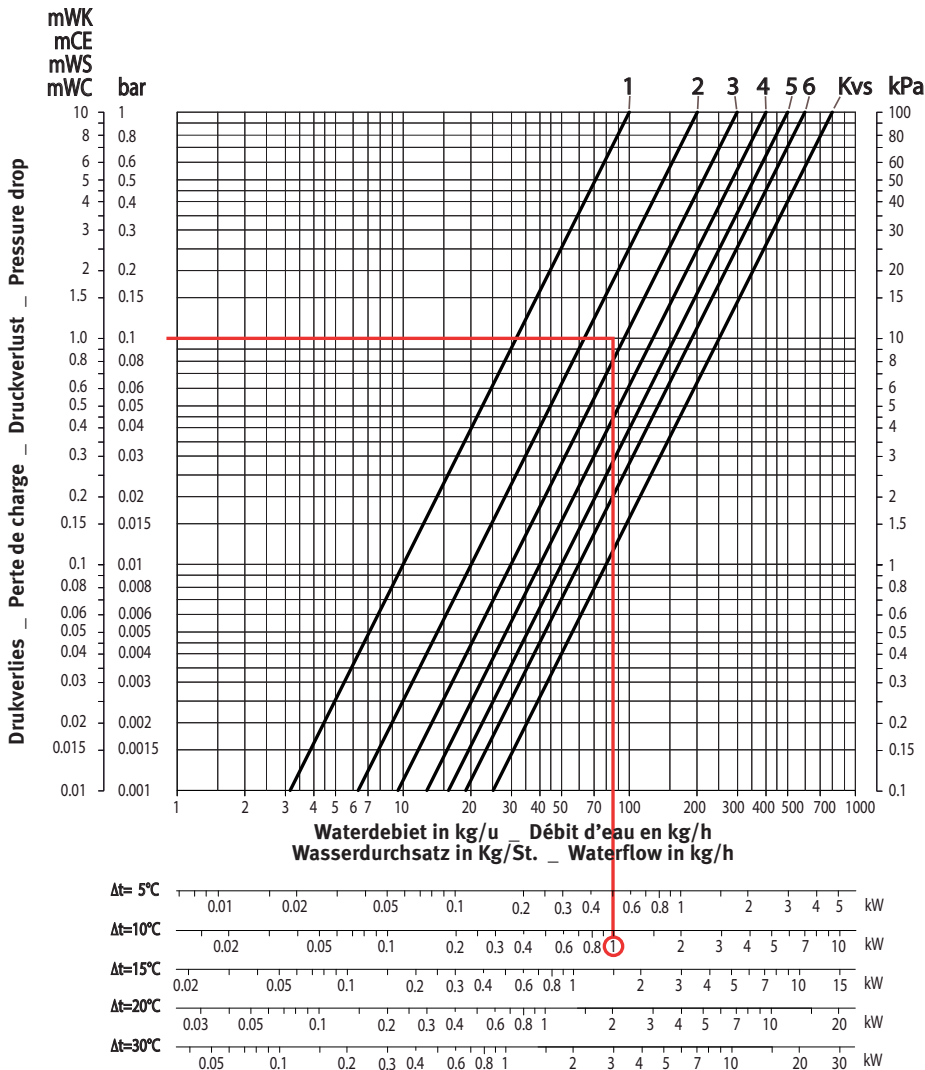

Voorinstelling van het Jaga ventiel Préréglage de la vanne Jaga Voreinstellung des Jaga Ventils Balancing control of the Jaga TRV

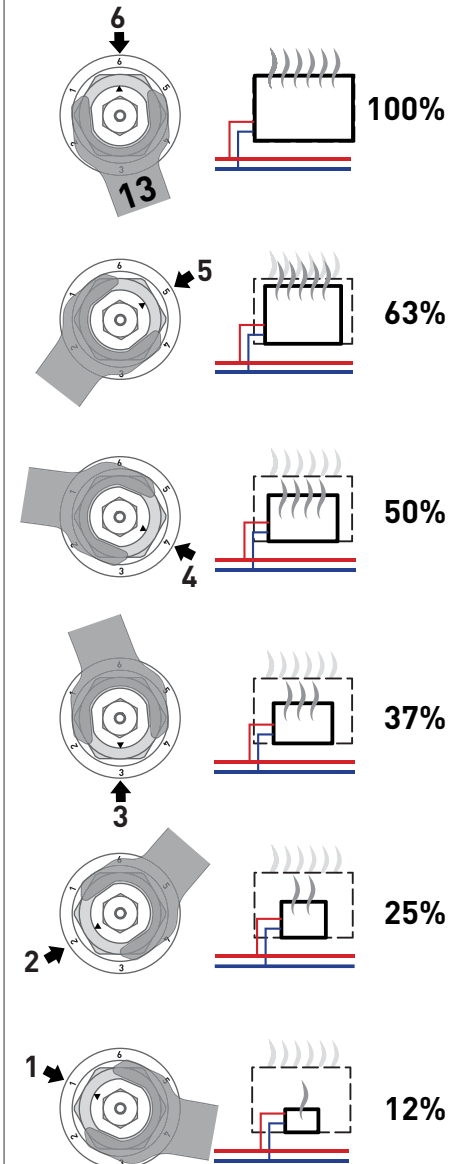
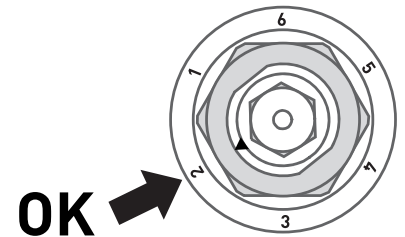
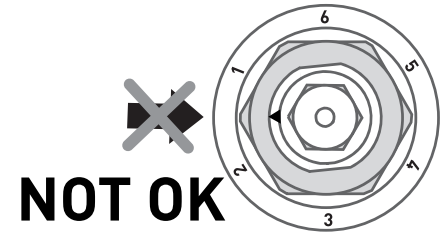

Demontage van de warmtewisselaar Démontage de l'échangeur de chaleur Demontage des Wärmetauschers Unmounting of the heat exchanger

- Sluit de thermostaatkop (1), sluit het retour-ventiel (2), schroef het ventiel en het retourventiel los (3).
- Fermer le thermostatique (1), fermer le raccord de réglage (2), dévisser la vanne et le raccord de réglage (3).
- Thermostatkopf schliessen (1), Rücklaufverschraubung schliessen (2), Ventil und Rücklaufverschraubung losschrauben (3).
- Close the TRV (1), close the lockshield (2), unscrew the valve and the lockshield (3).

