



**jaga**

**TEMPO**

Technical information

# TEMPO ■ OVERVIEW HEAT EXCHANGERS

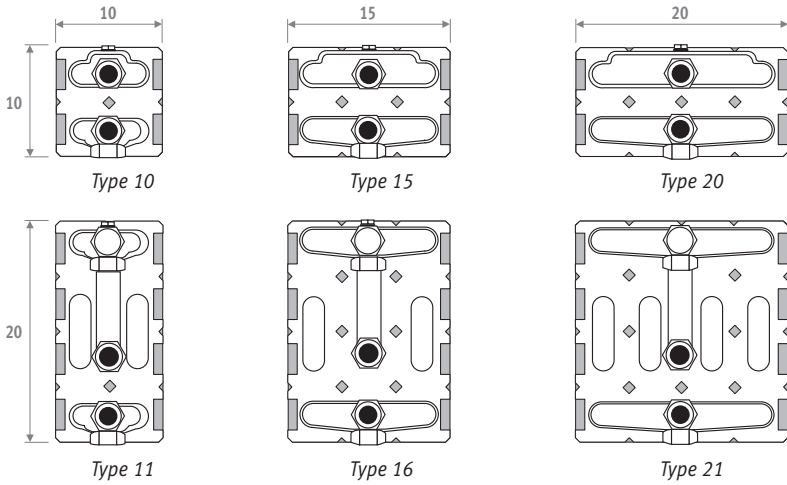

Weight and water content without packaging or options.

WALL MOUNTED MODEL WEIGHT (IN KG/METRE)							
Type	H	20	30	40	50	60	70
10		5.4	6.6	7.8	9.0	10.3	11.5
11	---		8.2	9.4	10.7	11.9	13.1
15		6.7	8.1	9.5	10.8	12.2	13.6
16	---		10.8	12.2	13.6	14.9	16.3
20		8.3	9.8	11.3	12.9	14.4	15.9
21	---		13.4	14.9	16.4	17.9	19.4

WATER CONTENT (IN LITRES/METRE)	
Type	All heights
10	0.65
11	1.33
15	0.98
16	1.98
20	1.32
21	2.66

FREESTANDING MODEL WEIGHT (IN KG/METRE)					
Type	H	20	30	40	50
10		8.2	10.2	12.2	14.2
11	---		11.9	13.9	15.9
15		9.7	11.8	14.0	16.1
16	---		14.7	16.9	19.0
20		11.2	13.5	15.7	18.0
21	---		17.1	19.4	21.7

# CORRECTION FACTORS - TEMPO

## AVERAGE CORRECTION FACTORS ACCORDING TO EN442 - 75/65/20°C

Tv	Tl	Tr	25	30	35	40	45	50	55	60	65	70	75	80	85
90	18		0.45	0.58	0.69	0.79	0.89	0.98	1.07	1.16	1.24	1.34	1.41	1.49	1.56
	20		0.38	0.52	0.63	0.74	0.83	0.92	1.01	1.10	1.18	1.28	1.35	1.43	1.50
	22		0.30	0.46	0.57	0.68	0.78	0.87	0.96	1.04	1.13	1.22	1.30	1.37	1.44
	24		0.20	0.39	0.52	0.62	0.72	0.81	0.90	0.99	1.07	1.15	1.24	1.31	1.38
85	18		0.42	0.54	0.65	0.75	0.84	0.93	1.01	1.10	1.20	1.27	1.34	1.41	
	20		0.36	0.49	0.59	0.69	0.79	0.87	0.96	1.04	1.12	1.21	1.28	1.35	
	22		0.28	0.42	0.54	0.64	0.73	0.82	0.90	0.99	1.06	1.15	1.22	1.30	
	24		0.19	0.36	0.48	0.58	0.68	0.76	0.85	0.93	1.01	1.10	1.17	1.24	
80	18		0.39	0.51	0.61	0.70	0.79	0.88	0.96	1.04	1.12	1.20	1.27		
	20		0.33	0.45	0.56	0.65	0.74	0.82	0.90	0.98	1.07	1.14	1.21		
	22		0.26	0.39	0.50	0.60	0.68	0.77	0.85	0.93	1.01	1.08	1.15		
	24		0.17	0.34	0.45	0.54	0.63	0.72	0.80	0.87	0.96	1.03	1.10		
75	18		0.37	0.47	0.57	0.66	0.74	0.82	0.90	0.99	1.05	1.12			
	20		0.30	0.42	0.52	0.61	0.69	0.77	0.85	0.93	1.00	1.07			
	22		0.24	0.36	0.46	0.55	0.64	0.72	0.79	0.88	0.95	1.01			
	24		0.16	0.31	0.41	0.50	0.59	0.67	0.74	0.83	0.89	0.96			
70	18		0.34	0.44	0.53	0.61	0.69	0.77	0.85	0.92	0.99				
	20		0.28	0.39	0.48	0.56	0.64	0.72	0.80	0.87	0.93				
	22		0.22	0.33	0.43	0.51	0.59	0.67	0.74	0.81	0.88				
	24		0.14	0.28	0.38	0.46	0.54	0.62	0.69	0.76	0.83				
65	18		0.31	0.40	0.49	0.57	0.64	0.71	0.79	0.85					
	20		0.25	0.35	0.44	0.52	0.59	0.66	0.74	0.80					
	22		0.19	0.30	0.39	0.47	0.54	0.61	0.69	0.75					
	24		0.12	0.25	0.34	0.42	0.50	0.57	0.64	0.70					
60	18		0.28	0.37	0.45	0.52	0.59	0.66	0.73						
	20		0.23	0.32	0.40	0.47	0.54	0.62	0.68						
	22		0.17	0.27	0.35	0.43	0.50	0.57	0.63						
	24		0.11	0.23	0.31	0.38	0.45	0.52	0.58						
55	18		0.25	0.33	0.40	0.47	0.55	0.60							
	20		0.20	0.29	0.36	0.43	0.50	0.56							
	22		0.15	0.24	0.32	0.38	0.45	0.51							
	24		0.09	0.20	0.27	0.34	0.40	0.47							
50	18		0.22	0.30	0.36	0.43	0.49								
	20		0.18	0.25	0.32	0.38	0.44								
	22		0.13	0.21	0.28	0.34	0.40								
	24		0.08	0.17	0.24	0.30	0.36								
45	18		0.19	0.26	0.32	0.38									
	20		0.15	0.22	0.28	0.34									
	22		0.11	0.18	0.24	0.30									
	24		0.06	0.14	0.20	0.26									
40	18		0.16	0.22	0.28										
	20		0.12	0.18	0.24										
	22		0.09	0.15	0.20										
	24		0.05	0.12	0.17										
35	18		0.13	0.19											
	20		0.10	0.15											
	22		0.07	0.12											
	24		0.03	0.09											
30	18		0.10												
	20		0.07												
	22		0.04												
	24		0.02												

The indicated outputs with  $\Delta T$  50 and  $\Delta T$  60 are the exact outputs.  $\Delta T$  50 output measured in accordance with EN 442 and  $\Delta T$  60 output calculated according to EN 442. An average correction factor is given in this table for all other  $\Delta T$  outputs, applicable for all dimensions.

# TEMPO - PRESSURE DROP

## PRESSURE DROP TYPE 10

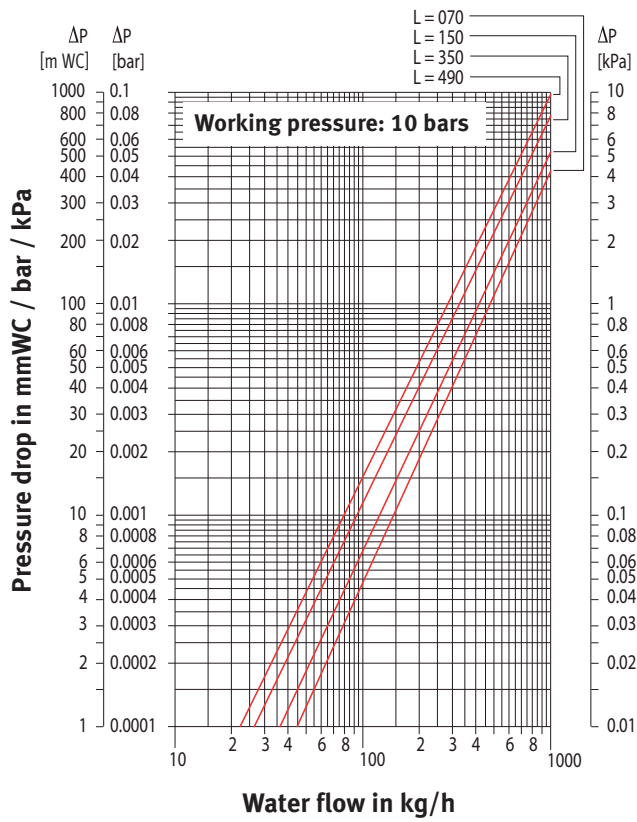

## PRESSURE DROP TYPE 11

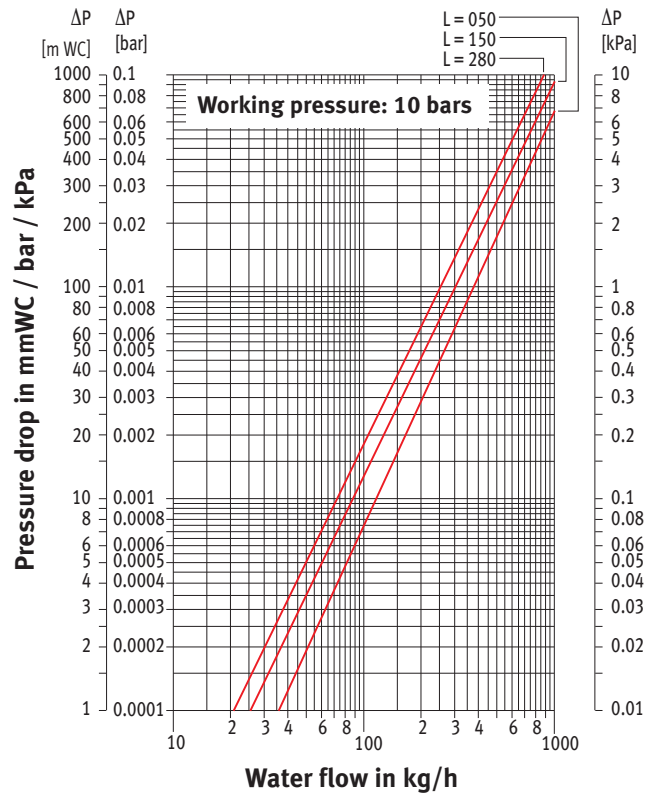

## PRESSURE DROP TYPE 15

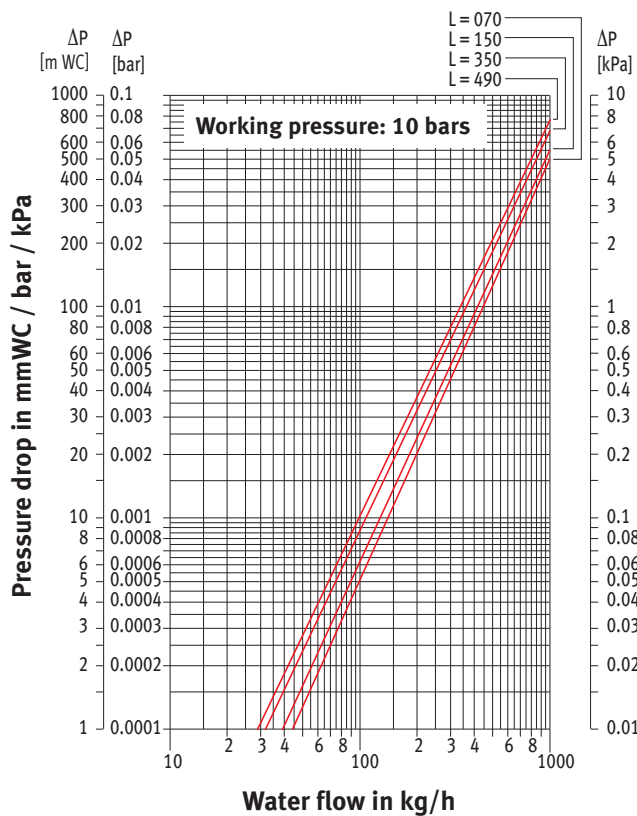

## PRESSURE DROP TYPE 16

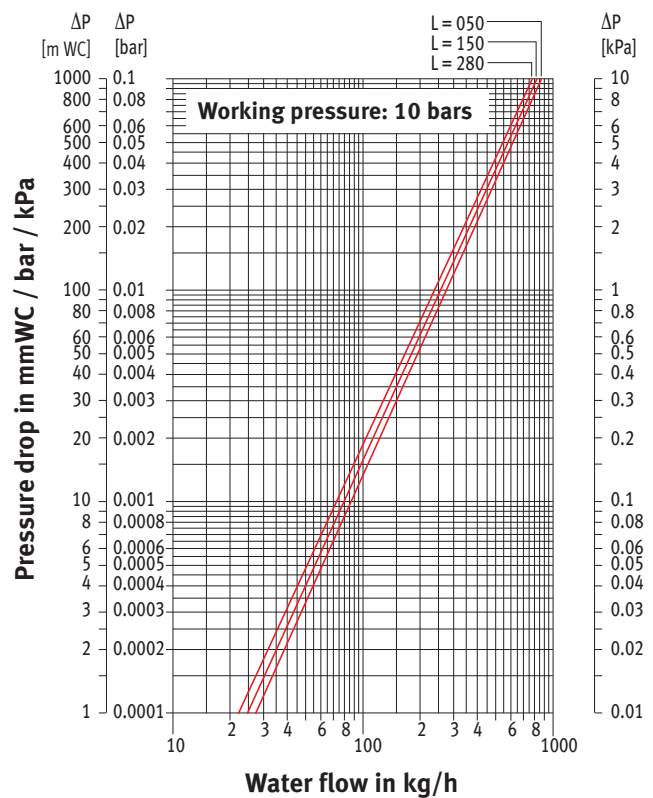

# TEMPO ■ PRESSURE DROP

## PRESSURE DROP TYPE 20

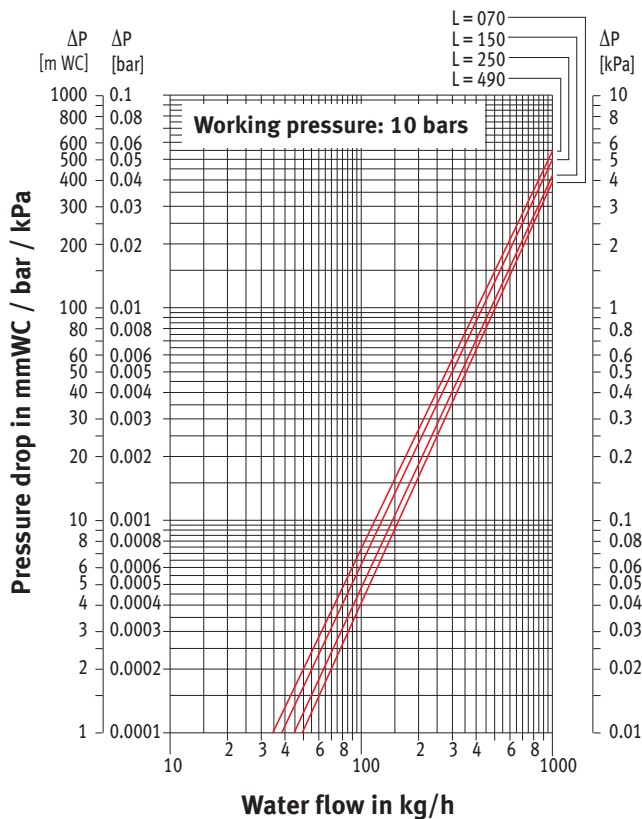

## PRESSURE DROP TYPE 21

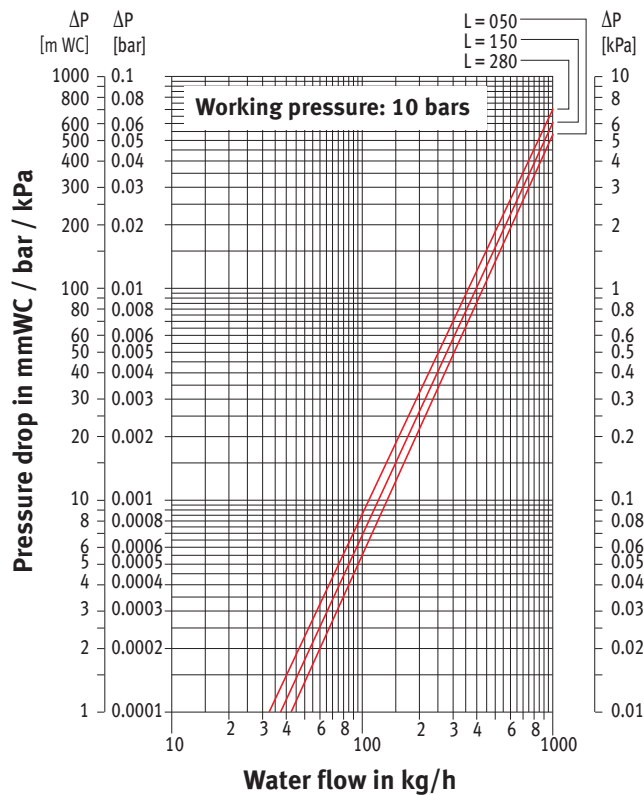

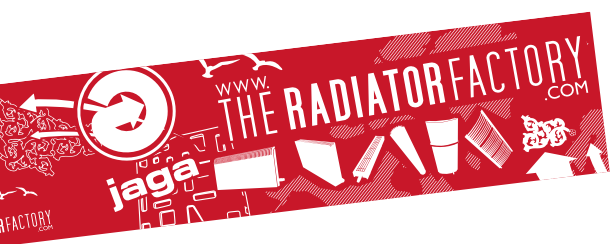

Jaga International  
Verbindingslaan 16  
B-3590 Diepenbeek

Tel.: +32 11 29 41 12  
Fax: +32 11 29 41 60  
E-mail: [export@jaga.be](mailto:export@jaga.be)  
[www.jaga.be](http://www.jaga.be)

The information in this price list is correct at the time of printing.  
Jaga reserves the right to change product specification at any time in  
line with our policy of continuous improvement and innovation.