

jaga

CLIMATE DESIGNERS

Heating



Light cooling



Deep cooling



BRISE € 2020.EX



jaga

CLIMATE DESIGNERS

BRISE

Super-power for heating, cooling and ventilation.

Brise keeps a tight rein on temperatures and is full of energy, controlling your interior climate with precision through the range of activator controlled settings. Heating. Ventilating. Cooling. Regardless, this radiator is always in pole position, ready to win the race for comfort.

Flexible application.

For climate control in shops, offices, schools, hotels, conference rooms, conservatories, etc...

High comfort with efficient energy use

Due to its very low water content and high capacity Jaga fan convectors react immediately to strong temperature changes.

Perfect design

The Brise is not only a technically superb product, it distinguishes itself also by a stylish design and impeccable finish, which makes it blend into any interior design.

Suitable for non-condensing and condensing cooling with chilled water





BRISE



BRISE - WALL MOUNTED MODEL

DIMENSIONS (in cm)

BRIW/BRIF

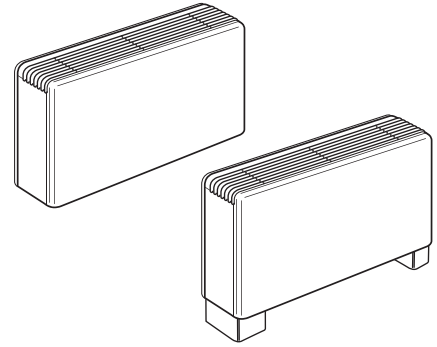
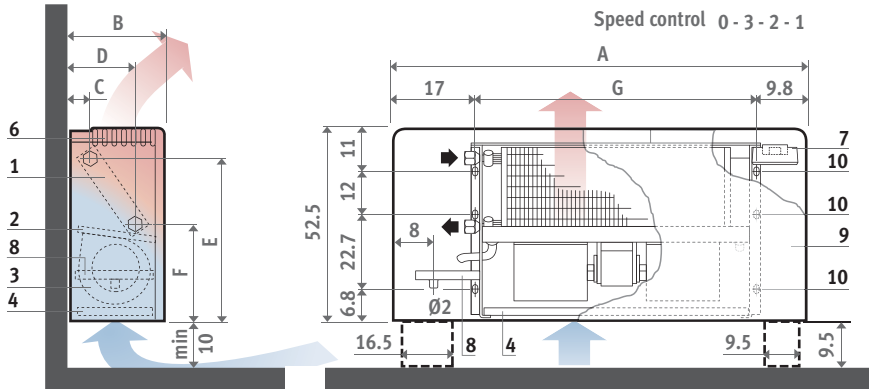

BRIF = BRIW + feet + rear panel.
Feet equipped with cover plate for electrical and hydraulic connections.

BUILDING-IN BRBW

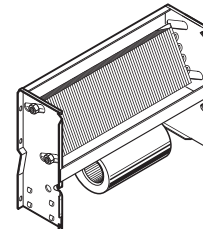
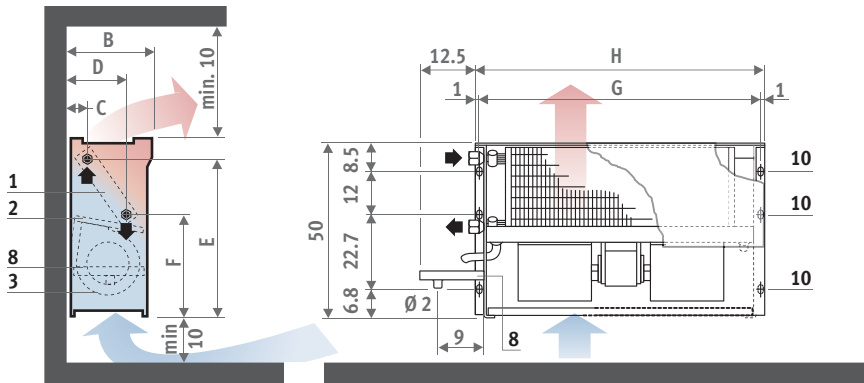

The model BRBW can be fitted horizontally for heating only.
Provide an air vent on the central heating pipe work.

Type	02	03	04	06	08	10
A	82.5	82.5	110.0	110.0	137.5	165.0
B	23.0	23.0	23.0	23.0	27.5	27.5
C	4.5	4.5	4.5	4.5	4.5	4.5
D	15.3	15.3	15.3	15.3	22.5	22.5
E	45.5	45.5	45.5	45.5	46.3	46.3
F	25.5	25.5	25.5	25.5	26.0	26.0
G	55.7	55.7	83.2	83.2	110.7	138.2
H	57.5	57.5	85.2	85.2	112.7	140.2
I	36.5	36.5	36.5	36.5	41.0	41.0
conn. heat exchanger	1/2" G	1/2" G	1/2" G	3/4" G	3/4" G	3/4" G
conn. air vent	1/8"	1/8"	1/8"	1/8"	1/8"	1/8"

1. heat exchanger
2. condensation tray
3. fan(s)
4. not recyclable air filter (option)
5. air inlet grille
6. air exhausting grille
7. switch
8. additional condensation tray (option)
9. casing
10. holes for wall fixing

ORDERING CODE

code type
BRIW . 02
fill in type

STANDARD DELIVERY

Pre-assembled fan radiator, Supplied in a handy cardboard box. Type BRIW/BRIF and BRBW with metal casing with smooth metallic paint in light grey and discharge vents in dark grey ABS (Acrylonitrile Butadiene Styrene).
Standard delivery includes:

- centrifugal fan(s) motor to condense in 3 speeds continuously and integrated KLIXON safety with an automatic reset.
- re-usable air filter with galvanised chassis for the BRIW and BRIF models
- built-in 3-position speed controller for the BRIW and BRIF models
- condensation tray with drain

HYDRAULIC CONNECTION

Standard connection left
- type 02, 03 and 04: 1/2"
- type 06, 08 and 10: 3/4"
Connection right on request:
Connection condensation drain pipe \varnothing 2 cm

ELECTRIC CONNECTION

Electric connection 230 VAC always right

Easy to install: the appliances are light and compact. The construction is perfectly designed up to the smallest detail in order to keep the installation as easy as possible.

CEILING-MOUNTED MODEL - BRISE

DIMENSIONS (in cm)

WITH CASING BRIC

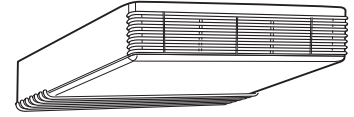
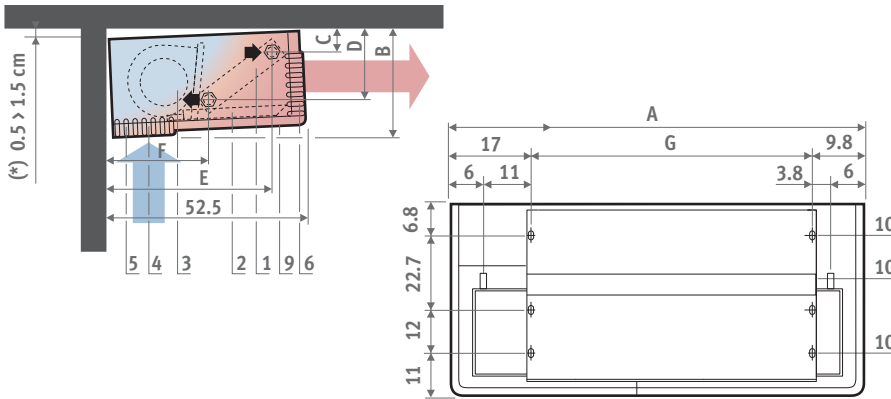

Max. height of the ceiling: 2.80 m.

(*) Fit the ventilo-fan convector at a slight upward angle to facilitate the drainage of the condensate.

The model BRIC or BRBC may also be fitted vertically, it is only to be used for heating. Provide an air vent on the central pipe work .

BUILDING-IN BRBC

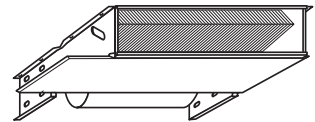
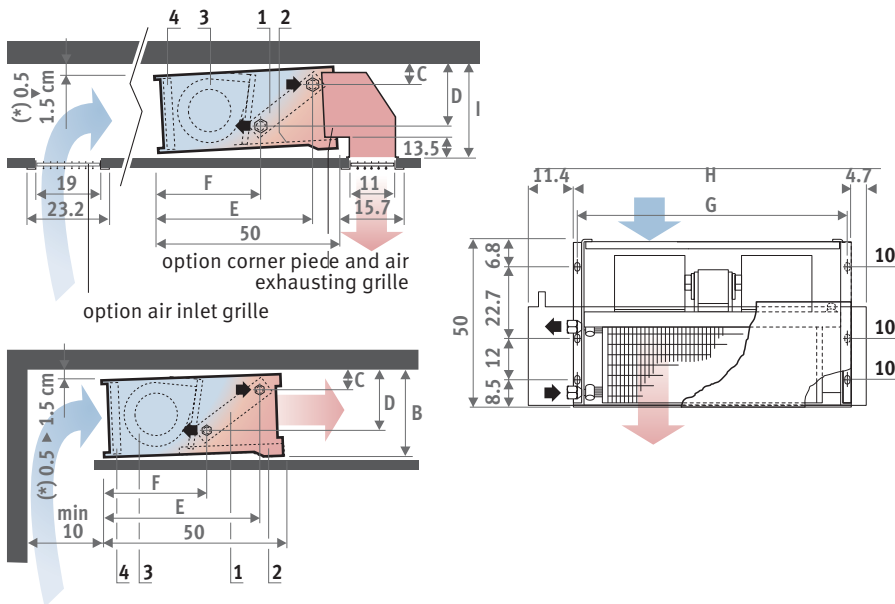

Option air inlet grille: do not mount it too close to the Brise to avoid the possibility that the exhausted hot air will be sucked in again.

Max. height of the ceiling: 2.80 m.

(*) Fit the ventilo-fan convector at a slight upward angle to facilitate the drainage of the condensate.

The model BRIC or BRBC may also be fitted vertically, it is only to be used for heating. Provide an air vent on the central pipe work .

BRISE

Ordering example: **BRIW**. type

STANDARD HEAT EXCHANGER

TYPE	HEATING									COOLING						wall		ceiling		freestanding
	kW 75/65/20°C			kW 55/45/20°C			kW 35/30/20°C			kW total 7/12°C - 27°C D.B. 47% R.H.			kW sensible 7/12°C - 27°C D.B. 47% R.H.			casing	con.	casing	con.	casing
	max.	med.	min.	max.	med.	min.	max.	med.	min.	max.	med.	min.	max.	med.	min.	BRIW	BRBW	BRIC	BRBC	BRIF
	€	€	€	€	€	€	€	€	€	€	€	€	€	€	€	€	€	€	€	€
02	4.00	3.60	3.04	2.40	2.16	1.82	1.00	0.90	0.76	1.84	1.65	1.37	1.26	1.12	0.95	1015,00	899,00	1083,00	915,00	1213,00
03	5.56	5.00	4.22	3.34	3.00	2.53	1.39	1.25	1.06	2.58	2.31	1.94	1.82	1.63	1.37	1030,00	915,00	1103,00	934,00	1228,00
04	8.07	7.26	6.13	4.84	4.36	3.68	2.02	1.82	1.53	3.80	3.41	2.87	2.60	2.34	1.97	1252,00	1103,00	1352,00	1136,00	1460,00
06	11.53	10.38	8.76	6.92	6.23	5.26	2.88	2.60	2.19	5.63	5.06	4.23	3.84	3.45	2.90	1386,00	1237,00	1485,00	1270,00	1593,00
08	19.48	16.78	14.17	11.69	10.07	8.50	4.87	4.20	3.54	9.23	8.30	6.98	6.35	5.72	4.81	2044,00	1853,00	2213,00	1882,00	2281,00
10	21.02	18.92	15.97	12.61	11.35	9.58	5.26	4.73	3.99	11.47	10.11	8.47	7.55	6.80	5.72	2604,00	2400,00	2817,00	2408,00	2854,00

Cooling performance according EN 1397:2016

OPTION SECOND HEAT EXCHANGER B4

TYPE	HEATING									SURCHARGE	
	kW 75/65/20°C			kW 55/45/20°C			kW 35/30/20°C			Code	€
	max.	med.	min.	max.	med.	min.	max.	med.	min.		
	€	€	€	€	€	€	€	€	€		
02	2.85	2.57	2.17	1.71	1.54	1.30	0.71	0.64	0.54	8721.5112	221,00
03	2.85	2.57	2.17	1.71	1.54	1.30	0.71	0.64	0.54	8721.5112	221,00
04	3.83	3.45	2.92	2.30	2.07	1.75	0.96	0.86	0.73	8721.5113	253,00
06	5.63	5.06	4.28	3.38	3.04	2.57	1.41	1.27	1.07	8721.5114	283,00
08	9.22	7.71	7.01	5.53	4.63	4.21	2.31	1.93	1.75	8721.5115	335,00
10	10.65	9.58	8.09	6.39	5.75	4.85	2.66	2.40	2.02	8721.5116	405,00

Options are fitted when fan convector and options are ordered together. With built-in options, delivery time will be longer. With second heat exchanger B4, the standard heat exchanger has to be used for cooling and the second heat exchanger B4 for heating.

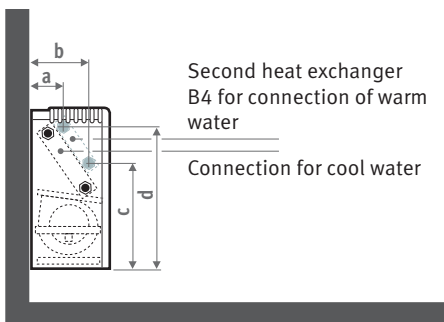

Type	02	03	04	06	08	10
a	9	9	9	9	9.5	9.5
b	19.8	19.8	19.8	19.8	24	24
c	28	28	28	28	31.5	31.5
d	48	48	48	48	48	48

RECOMMENDED COMBINATIONS

	heating and cooling
Product	Brise
Regulation	Speed control / thermostat 8762.0000 Or wall mounting thermostat heating/cooling 8751.050010

TECHNICAL DATA

TYPE	AIR FLOW*			MAX. MEASURED POWER	RATED CURRENT	HOT AIR CARRYING*	WATER CONTENT STANDARD		WEIGHT			
	m ³ /h			Watts	A	m	litre		kg			
	max.	med.	min.				heat exchanger		wall		ceiling	
							Standard	B4	casing	con.	casing	con.
02	380	295	220	45	0.21	4	0.66	0.21	18.0	14.0	18.0	14.5
03	500	390	290	68	0.32	6	0.86	0.27	19.0	14.5	19.0	15.0
04	700	545	410	103	0.48	7	1.34	0.44	24.0	15.0	24.0	20.0
06	880	690	510	125	0.59	9	1.96	0.65	26.0	20.5	26.0	22.0
08	1350	1050	720	193	0.92	7	3.75	1.24	38.0	33.0	38.0	33.0
10	1700	1325	955	210	0.99	11	4.03	1.34	50.0	43.5	50.0	43.5

* Measured with clean filter.

TECHNICAL DATA - SOUND

TYPE	SOUND PRESSURE*			SOUND POWER LEVEL ISO 23741/2																				
	dB(A) / NR			HZ 125		HZ 250		HZ 500		HZ 1000		HZ 2000		HZ 4000		HZ 8000								
	max.	med.	min.	max.	med.	min.	max.	med.	min.	max.	med.	min.	max.	med.	min.	max.	med.	min.						
02	41/36	35/31	29/25	48	45	42	46	44	39	46	40	35	42	36	30	37	30	23	32	26	23	25	24	20
03	41/36	35/31	29/25	52	46	42	52	45	40	42	36	30	47	37	31	44	31	23	40	27	22	37	26	20
04	44/39	36/32	30/26	49	44	38	50	43	38	47	37	31	49	37	32	39	30	24	36	26	21	33	25	20
06	50/46	37/33	31/27	53	45	38	55	44	39	49	37	32	51	38	34	46	30	25	41	27	22	37	27	21
08	50/45	43/38	37/33	55	49	45	57	50	43	51	44	35	51	44	35	47	39	30	43	36	27	34	30	21
10	53/50	43/38	37/33	58	50	46	60	51	46	55	46	40	55	46	40	53	44	34	47	38	29	39	29	27

* Measured model: model BRIW with casing, standard heat exchanger and a new filter. Height: 1 m, 2 m from the air exhaust grille. The sound level is influenced by the dimensions of the room, the reverberation time, other sound sources and the distance of the sound source.

BRISE

OPTIONS

Speed control / thermostat

Wall-mounted thermostat with on/off button and manual 3-position speed controller. Suitable for heating, cooling and ventilation. For 1 unit or for several units, combined with relay contacts.

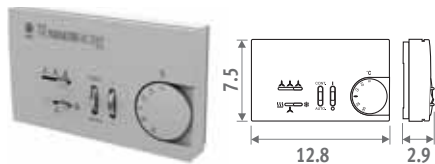

CODE	€
8762.0000	286,00

Filter

Recyclable air filter (standard at BRIW and BRIF, option at BRIC, BRBW and BRBC)

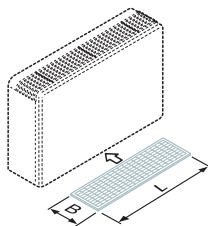

CODE	type	B x L	€
8721.121	02 - 03	21 x 53	43,00
8721.125	04 - 06	21 x 80.5	55,00
8721.115	08	25 x 108	75,00
8721.116	10	25 x 135.5	87,00

Condensation tray for model BRIW - BRIF - BRBW

Additional condensation tray for cooling. Position underneath the valves.

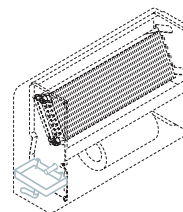

CODE	type	€
8769.0041	02 - 03 - 04 - 06	33,00
8769.0023	08 - 10	33,00

Rear panel for model BRIW

For freestanding models order feet separately.

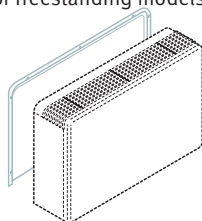

CODE	type	€
8770.121	02 - 03	99,00
8770.125	04 - 06	108,00
8770.115	08	137,00
8770.116	10	150,00

Fan-seal panel for model BRBW - BRBC

For air intake on 1 side and as air-conducting compartments.

Always order when using built in models.

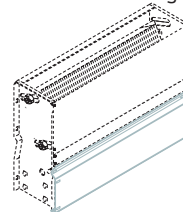

CODE	type	€
8775.0021	02 - 03	32,00
8775.0025	04 - 06	44,00
8775.0015	08	56,00
8775.0016	10	64,00

Feet for model BRIW - BRBW

Includes protective cover.

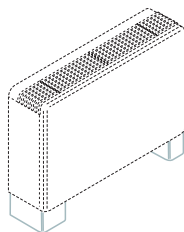

CODE	type	€
8767.141	02 - 03 - 04 - 06	99,00
8767.123	08 - 10	99,00

OPTIONS

Fan-seal panel for model BRIC

For visible mounting. Seal panel in the same colour as the radiator.

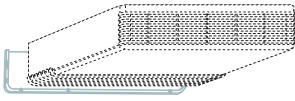

CODE	type	€
8771.121	02 - 03	67,00
8771.125	04 - 06	67,00
8771.115	08	74,00
8771.116	10	85,00

Transformation to exhaust downwards for model BRIC

Includes fan-seal panel for BRIC. Maximum height of ceiling: 2.6 m. Maximum fitting height: 2.3 m.

Only available when ordering with the appliance

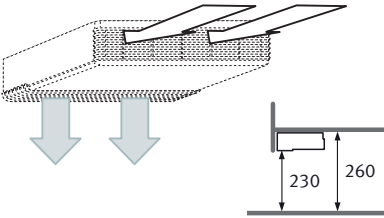

CODE	type	€
8774.0025	04 - 06	475,60
8774.0015	08	475,60
8774.0016	10	475,60

Plenum with 2 connections ø16 cm for model BRBC

Exhaust plenum for connection of two air channels. Maximum length of the channel 2 metre, without loss of air flow.

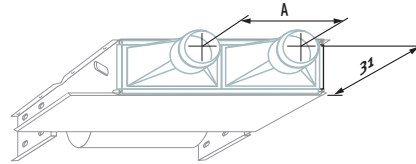

CODE	type	A	€
8764.0221	02 - 03	26.7	647,00
8764.0225	04 - 06	40.6	647,00
8764.0215	08	54.2	738,00
8764.0216	10	67.9	866,00

Plenum with connection ø31.5 cm for model BRBC

Exhaust plenum for connection of one air channel. Maximum length of the channel 2 metre, without loss of air flow.

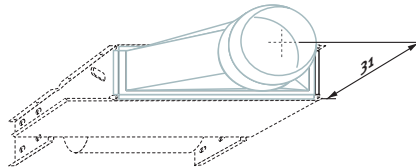

CODE	type	€
8764.0121	02 - 03	434,00
8764.0125	04 - 06	476,00
8764.0115	08	623,00
8764.0116	10	786,00

Air mixing box wall mounted model

1. Servo motor
2. Air mixing box
3. Air inlet grille

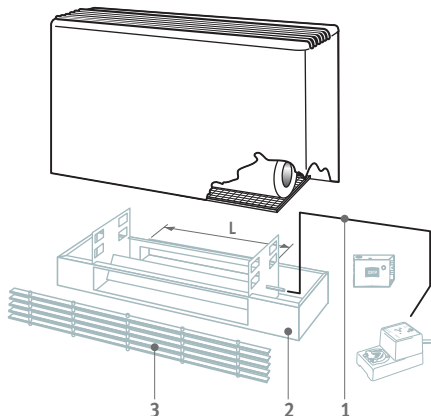

Air mixing box ceiling-mounted model

1. Air mixing box
2. Corner piece with
3. Fan-seal panel
4. Adjustable air inlet grille
5. Adjustable air exhaust grille

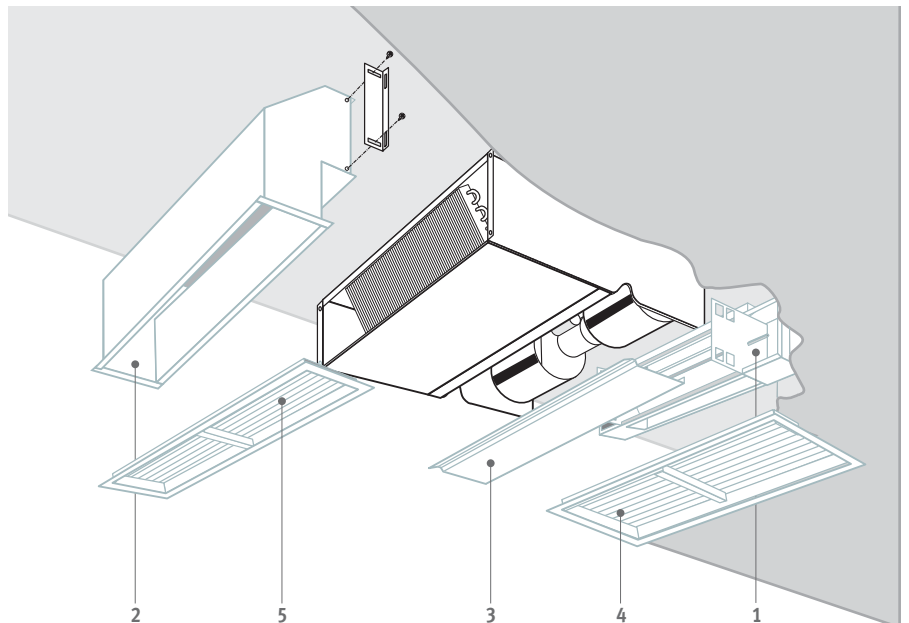

NOTES

jaga
CLIMATE
DESIGNERS

Jaga International
Verbindingslaan 16
B-3590 Diepenbeek

Tel.: +32 (0)11 29 41 12
Fax: +32 (0)11 29 41 60
export@jaga.com

The information in this price list is correct at the time of printing.
Jaga reserves the right to change product specification at any time in line
with our policy of continuous improvement and innovation.
All prices in Euro, exclude VAT. Prices valid from 1st January 2020.
Replaces all existing price lists.